

## TEST REPORT



Applicant	Shenzhen SOFAR SOLAR Co., Ltd.
Address	401, Building 4, AnTongDa Industrial Park, District 68, XingDong Community, XinAn Street, BaoAn District, Shenzhen, China.

Manufacturer or Supplier	Shenzhen SOFAR SOLAR Co., Ltd.	
Address	401, Building 4, AnTongDa Industrial Park, District 68, XingDong Community, XinAn Street, BaoAn District, Shenzhen, China.	
Product	Hybrid Inverter	
Brand Name	SOFARSOLAR	
Model	HYD 6000-ES, HYD 4000-ES, HYD 3000-ES	
Additional Model & Model Difference	HYD 5000-ES, HYD 3600-ES, HYD 4600-ES; See items 2.1	
Date of tests	Sep. 03, 2018 ~Oct. 09, 2018	

The submitted sample of the above equipment has been tested according to the requirements of the following standards:

- EN 61000-6-3:2007 + A1:2011+ AC: 2012(IEC 61000-6-3:2006 + A1:2010)
- EN 61000-3-2:2014(IEC 61000-3-2:2018)
- EN 61000-3-3:2013(IEC 61000-3-3:2013+A1:2017)
- EN 61000-3-11:2001(IEC 61000-3-11:2017)
- EN 61000-3-12:2011(IEC 61000-3-12:2011)
- EN 61000-6-2:2005(IEC 61000-6-2:2016)

**CONCLUSION: The submitted sample was found to COMPLY with the test requirement**

<p>Tested by Ryan Lu Project Engineer / EMC Department</p>	<p>Approved by Glyn He Assistant Manager / EMC Department</p>
	
<p>Date: Apr. 14, 2020</p>	

This report is governed by, and incorporates by reference, CPS Conditions of Service as posted at the date of issuance of this report at <http://www.bureauveritas.com/home/about-us/our-business/cps/about-us/terms-conditions/> and is intended for your exclusive use. Any copying or replication of this report to or for any other person or entity, or use of our name or trademark, is permitted only with our prior written permission. This report sets forth our findings solely with respect to the test samples identified herein. The results set forth in this report are not indicative or representative of the quality or characteristics of the lot from which a test sample was taken or any similar or identical product unless specifically and expressly noted. Our report includes all of the tests requested by you and the results thereof based upon the information that you provided to us. Measurement uncertainty is only provided upon request for accredited tests. You have 60 days from date of issuance of this report to notify us of any material error or omission caused by our negligence or if you require measurement uncertainty; provided, however, that such notice shall be in writing and shall specifically address the issue you wish to raise. A failure to raise such issue within the prescribed time shall constitute your unqualified acceptance of the completeness of this report, the tests conducted and the correctness of the report contents.



# TABLE OF CONTENTS

RELEASE CONTROL RECORD ..... 4

1 SUMMARY OF TEST RESULTS ..... 5

1.1 MEASUREMENT UNCERTAINTY ..... 7

2 GENERAL INFORMATION ..... 8

2.1 GENERAL DESCRIPTION OF EUT ..... 8

2.2 DESCRIPTION OF TEST MODES ..... 9

2.3 GENERAL DESCRIPTION OF APPLIED STANDARDS ..... 11

2.4 DESCRIPTION OF SUPPORT UNITS ..... 11

3 EMISSION TEST ..... 12

3.1 CONDUCTED EMISSION MEASUREMENT ..... 12

3.1.1 LIMITS OF CONDUCTED EMISSION MEASUREMENT ..... 12

3.1.2 TEST INSTRUMENTS ..... 12

3.1.3 TEST PROCEDURE ..... 13

3.1.4 DEVIATION FROM TEST STANDARD ..... 13

3.1.5 TEST SETUP ..... 13

3.1.6 EUT OPERATING CONDITIONS ..... 13

3.1.7 TEST RESULTS ..... 14

3.2 RADIATED EMISSION MEASUREMENT ..... 16

3.2.1 LIMITS OF RADIATED EMISSION MEASUREMENT ..... 16

3.2.2 TEST INSTRUMENTS ..... 17

3.2.3 TEST PROCEDURE ..... 18

3.2.4 DEVIATION FROM TEST STANDARD ..... 19

3.2.5 TEST SETUP ..... 20

3.2.6 EUT OPERATING CONDITIONS ..... 20

3.2.7 TEST RESULTS ..... 21

3.3 HARMONICS CURRENT MEASUREMENT ..... 23

3.3.1 TEST INSTRUMENTS ..... 23

3.3.2 DEVIATION FROM TEST STANDARD ..... 23

3.3.3 TEST SETUP ..... 23

3.3.4 EUT OPERATING CONDITIONS ..... 23

3.3.5 TEST RESULTS ..... 24

3.4 VOLTAGE FLUCTUATION AND FLICKS MEASUREMENT ..... 27

3.4.1 TEST INSTRUMENTS ..... 27

3.4.2 TEST PROCEDURE ..... 27

3.4.3 DEVIATION FROM TEST STANDARD ..... 27

3.4.4 TEST SETUP ..... 27

3.4.5 EUT OPERATING CONDITIONS ..... 27

3.4.6 TEST RESULTS ..... 28

4 IMMUNITY TEST ..... 29

4.1 GENERAL DESCRIPTION ..... 29

4.1.1 GENERAL DESCRIPTION OF EN 61000-6-2 ..... 29

4.1.2 PERFORMANCE CRITERIA ..... 30

4.1.3 EUT OPERATING CONDITION ..... 30



4.2	ELECTROSTATIC DISCHARGE IMMUNITY TEST (ESD) .....	31
4.2.1	TEST SPECIFICATION .....	31
4.2.2	TEST INSTRUMENTS.....	31
4.2.3	TEST PROCEDURE.....	32
4.2.4	DEVIATION FROM TEST STANDARD.....	32
4.2.5	TEST SETUP.....	33
4.2.6	TEST RESULTS .....	34
4.3	RADIATED, RADIO-FREQUENCY, ELECTROMAGNETIC FIELD.....	36
	IMMUNITY TEST (RS) .....	36
4.3.1	TEST SPECIFICATION .....	36
4.3.2	TEST INSTRUMENTS.....	36
4.3.3	TEST PROCEDURE.....	37
4.3.4	DEVIATION FROM TEST STANDARD.....	37
4.3.5	TEST SETUP.....	37
4.3.6	TEST RESULTS .....	38
4.4	ELECTRICAL FAST TRANSIENT/BURST IMMUNITY TEST (EFT) .....	39
4.4.1	TEST SPECIFICATION .....	39
4.4.2	TEST INSTRUMENTS.....	39
4.4.3	TEST PROCEDURE.....	39
4.4.4	DEVIATION FROM TEST STANDARD.....	39
4.4.5	TEST SETUP.....	40
4.4.6	TEST RESULTS .....	41
4.5	SURGE IMMUNITY TEST .....	42
4.5.1	TEST SPECIFICATION .....	42
4.5.2	TEST INSTRUMENTS.....	42
4.5.3	TEST PROCEDURE.....	43
4.5.4	DEVIATION FROM TEST STANDARD.....	43
4.5.5	TEST SETUP.....	43
4.5.6	TEST RESULTS .....	44
4.6	IMMUNITY TO CONDUCTED DISTURBANCES INDUCED BY RF.....	45
	FIELDS (CS).....	45
4.6.1	TEST SPECIFICATION .....	45
4.6.2	TEST INSTRUMENTS.....	45
4.6.3	TEST PROCEDURE.....	46
4.6.4	DEVIATION FROM TEST STANDARD.....	46
4.6.5	TEST SETUP.....	47
4.6.6	TEST RESULTS .....	48
4.7	POWER FREQUENCY MAGNETIC FIELD IMMUNITY TEST .....	49
4.7.1	TEST SPECIFICATION .....	49
4.7.2	TEST INSTRUMENTS.....	49
4.7.3	TEST PROCEDURE.....	49
4.7.4	DEVIATION FROM TEST STANDARD.....	49
4.7.5	TEST SETUP.....	50
4.7.6	TEST RESULTS .....	51
5	PHOTOGRAPHS OF THE TEST CONFIGURATION .....	52
6	APPENDIX A – MODIFICATIONS RECORDERS FOR ENGINEERING CHANGES TO THE EUT BY THE LAB .....	57



## RELEASE CONTROL RECORD

ISSUE NO.	REASON FOR CHANGE	DATE ISSUED
CE180903N042	Original release	Oct. 16, 2018
CE190808N030	Based on the original report CE180903N042 changed the information of applicant/ manufacturer, added additional model, but it doesn't need to be retested after engineer evaluated.	Sep. 20, 2019
C200320N024-3	Based on the original report CE190808N030 added the IEC standard, and changed the information of manufacturer, it doesn't need to be retested after engineer evaluated.	Apr. 14, 2020



## 1 SUMMARY OF TEST RESULTS

The EUT has been tested according to the following specifications:

EMISSION			
Standard	Test Type	Result	Remarks
IEC 61000-6-3:2006+ A1:2010	Conducted test	PASS	Meets Limits Minimum passing margin is -2.28dB at 13.57031 MHz
	Radiated test (30MHz~1GHz)	PASS	Meets limits minimum passing margin is -0.60dB at 30.000 MHz
IEC 61000-3-2:2018	Harmonic current emissions	PASS	Meets the requirements.
IEC 61000-3-3:2013+ A1:2017	Voltage fluctuations & flicker	PASS	Meets the requirements.
IEC 61000-3-12:2011	Harmonic current emissions	PASS	Meets the requirements.
IEC 61000-3-11:2017	Voltage fluctuations & flicker	PASS	Meets the requirements.



<b>IMMUNITY (IEC 61000-6-2:2016)</b>			
<b>Standard</b>	<b>Test Type</b>	<b>Result</b>	<b>Remarks</b>
IEC 61000-4-2:2008 ED. 2.0	Electrostatic discharge immunity test	PASS	Electrostatic Discharge – ESD: 8kV Air discharge, 4kV Contact discharge, Performance Criterion A
IEC 61000-4-3:2010 ED. 3.2	Radiated, radio-frequency, electromagnetic field immunity test	PASS	Radio-Frequency Electromagnetic Field Susceptibility Test – RS: 80-1000 MHz, 10V/m, 80% AM (1kHz), 1400-2000 MHz, 3V/m, 80% AM (1kHz) 2000-2700 MHz, 1V/m, 80% AM (1kHz) Performance Criterion A
IEC 61000-4-4:2012 ED. 3.0	Electrical fast transient / burst immunity test.	PASS	Electrical Fast Transient/Burst - EFT AC Power line: 2kV, DC Power line 2kV, Performance Criterion A
IEC 61000-4-5:2017 ED. 3.1	Surge immunity test	PASS	Surge Immunity Test: 1.2/50 us Open Circuit Voltage, 8 /20 us Short Circuit Current, AC Power Line: line to line 1 kV, line to earth 2kV, DC Power Line: line to line 0.5kV Performance Criterion B
IEC 61000-4-6:2013 ED. 4.0	Immunity to conducted disturbances, induced by radio-frequency fields	PASS	Conducted Radio Frequency Disturbances Test – CS: 0.15-80 MHz, 10Vrms, 80% AM, 1kHz, Performance Criterion A
IEC 61000-4-8:2009 ED. 2.0	Power frequency magnetic field immunity test.	PASS	Power Frequency Magnetic Field Test, 50 Hz, 30A/m, Performance Criterion A



## 1.1 MEASUREMENT UNCERTAINTY

Where relevant, the following measurement uncertainty levels have been estimated for tests performed on the EUT as specified in CISPR 16-4-2:

This uncertainty represents an expanded uncertainty expressed at approximately the 95% confidence level using a coverage factor of  $k=2$ .

MEASUREMENT	FREQUENCY	UNCERTAINTY
Mains Terminal Disturbance Voltage Test	0.15MHz ~ 30MHz	+ /-2.70 dB
Radiated Disturbance Test	30MHz ~ 1000MHz	+ /-4.04 dB



## 2 GENERAL INFORMATION

### 2.1 GENERAL DESCRIPTION OF EUT

<b>PRODUCT</b>	Hybrid Inverter
<b>MODEL NO.</b>	HYD 6000-ES, HYD 4000-ES, HYD 3000-ES
<b>ADDITIONAL MODELS</b>	HYD 5000-ES, HYD 3600-ES, HYD 4600-ES
<b>POWER SUPPLY</b>	For HYD 6000-ES:DC input: 300V-520V AC output: 184V-276V, Battery: DC 40-60V For HYD 4000-ES:DC input: 200V-520V AC output: 184V-276V, Battery: DC 40-60V For HYD 3000-ES:DC input: 160V-520V AC output: 184V-276V, Battery: DC 40-60V
<b>THE HIGHEST OPERATING FREQUENCY</b>	Below 108MHz
<b>DATA CABLE SUPPLIED</b>	N/A

#### NOTE:

1. For the test results, the EUT had been tested with all conditions. But only the worst case was showed in test report.
2. For a more detailed features description, please refer to the manufacturer's specifications or the User's Manual.
3. Please refer to the EUT photo document (Reference No.: 200320N024-3) for detailed product photo.
4. Additional models HYD 5000-ES, HYD 3600-ES, HYD 4600-ES are identical with the test models HYD 6000-ES, HYD 4000-ES, HYD 3000-ES except the model number, power rating and software for trading purpose. The difference has been considered during this test, full test was performed for the model HYD 6000-ES, partial test was performed for the model HYD 4000-ES, test conduction emission and radiated emission, other partial test was performed for the model HYD 3000-ES, test conduction emission, radiated emission, harmonics and flicker.





## 2.2 DESCRIPTION OF TEST MODES

The EUT was tested under the following modes' the final worst mode was marked in boldface and recorded in this report.

### ◆ For Conducted Emission Test

Description of Test Mode	Test Model	Test Voltage
Grid	HYD 6000-ES	Input: DC 520V/12.69A,Output: AC 230V/50Hz Input: DC 410V/16.10A,Output: AC 230V/50Hz Input: DC 300V/22A,Output: AC 230V/50Hz
Grid+ Battery charging		Input: DC 520V/12.69A,Output: AC 230V/50Hz
Battery charging from AC input		<b>AC230V/50Hz</b>
Battery discharging+ Grid		Input: DC 48V from battery, Output: AC 230V/50Hz
Battery discharging+ AC output		Input: DC 48V from battery, Output: AC 230V/50Hz
Grid	HYD 4000-ES	Input: DC 520V/8.46A,Output: AC 230V/50Hz Input: DC 360V/12.22A,Output: AC 230V/50Hz
Grid+ Battery charging		Input: DC 520V/8.46A,Output: AC 230V/50Hz
<b>Battery charging from AC input</b>		<b>AC230V/50Hz</b>
Battery discharging+ Grid		Input: DC 48V from battery, Output: AC 230V/50Hz
Battery discharging+ AC output		Input: DC 48V from battery, Output: AC 230V/50Hz
Grid	HYD 3000-ES	Input: DC 520V/6.35A,Output: AC 230V/50Hz Input: DC 340V/9.71A,Output: AC 230V/50Hz
Grid+ Battery charging		Input: DC 520V/6.35A,Output: AC 230V/50Hz
Battery charging from AC input		<b>AC230V/50Hz</b>
Battery discharging+ Grid		Input: DC 48V from battery, Output: AC 230V/50Hz
Battery discharging+ AC output		Input: DC 48V from battery, Output: AC 230V/50Hz



◆ For Radiated Emission Test

Description of Test Mode	Test Model	Test Voltage
Grid	HYD 6000-ES	Input: DC 520V/12.69A,Output: AC 230V/50Hz Input: DC 410V/16.10A,Output: AC 230V/50Hz Input: DC 300V/22A,Output: AC 230V/50Hz
Grid+ Battery charging		Input: DC 300V/22A,Output: AC 230V/50Hz
<b>Battery charging from AC input</b>		<b>AC230V/50Hz</b>
Battery discharging+ Grid		Input: DC 48V from battery, Output: AC 230V/50Hz
Battery discharging+ AC output		Input: DC 48V from battery, Output: AC 230V/50Hz
Grid	HYD 4000-ES	Input: DC 520V/8.46A,Output: AC 230V/50Hz Input: DC 360V/12.22A,Output: AC 230V/50Hz
Grid+ Battery charging		Input: DC 360V/12.22A,Output: AC 230V/50Hz
Battery charging from AC input		AC230V/50Hz
Battery discharging+ Grid		Input: DC 48V from battery, Output: AC 230V/50Hz
Battery discharging+ AC output		Input: DC 48V from battery, Output: AC 230V/50Hz
Grid	HYD 3000-ES	Input: DC 520V/6.35,Output: AC 230V/50Hz Input: DC 340V/9.71A,Output: AC 230V/50Hz
Grid+ Battery charging		Input: DC 340V/9.71A,Output: AC 230V/50Hz
Battery charging from AC input		AC230V/50Hz
Battery discharging+ Grid		Input: DC 48V from battery, Output: AC 230V/50Hz
Battery discharging+ AC output		Input: DC 48V from battery, Output: AC 230V/50Hz

◆ For Harmonics and Flicker Tests

Description of Test Mode	Test Model	Test Voltage
Grid	HYD 6000-ES	Input: DC 520V/12.69A,Output: AC 230V/50Hz
	HYD 3000-ES	Input: DC 520V/8.46A,Output: AC 230V/50Hz

◆ For Immunity Tests

Description of Test Mode	Test Model	Test Voltage
Grid	HYD 6000-ES	Input: DC 520V/12.69A, Output: AC 230V/50Hz Input: DC 410V/16.10A, Output: AC 230V/50Hz Input: DC 300V/22A, Output: AC 230V/50Hz
Grid+ Battery charging		Input: DC 300V/22A, Output: AC 230V/50Hz
Battery charging from AC input		AC230V/50Hz
Battery discharging+ Grid		Input: DC 48V from battery, Output: AC 230V/50Hz
Battery discharging+ AC output		Input: DC 48V from battery, Output: AC 230V/50Hz

## 2.3 GENERAL DESCRIPTION OF APPLIED STANDARDS

The EUT has been tested and complied with the requirements of the following standards:

**EN 61000-6-3:2007 + A1:2011+ AC: 2012(IEC 61000-6-3:2006 + A1:2010)**

**EN 61000-3-2:2014(IEC 61000-3-2:2018)**

**EN 61000-3-3:2013(IEC 61000-3-3:2013+A1:2017)**

**EN 61000-3-12:2011(IEC 61000-3-12:2011)**

**EN 61000-3-11:2001(IEC 61000-3-11:2017)**

**EN 61000-6-2:2005(IEC 61000-6-2:2016)**

IEC 61000-4-2:2008 ED. 2.0

IEC 61000-4-3:2010 ED. 3.2

IEC 61000-4-4:2012 ED. 3.0

IEC 61000-4-5:2017 ED. 3.1

IEC 61000-4-6:2013 ED. 4.0

IEC 61000-4-8:2009 ED. 2.0

**Notes:** The above IEC basic standards are applied with latest version if customer has no special requirement.

## 2.4 DESCRIPTION OF SUPPORT UNITS

The EUT has been tested as an independent unit without any other necessary accessory or support units.



### 3 EMISSION TEST

#### 3.1 CONDUCTED EMISSION MEASUREMENT

##### 3.1.1 LIMITS OF CONDUCTED EMISSION MEASUREMENT

FREQUENCY (MHz)	dBuV	
	Quasi-peak	Average
0.15 - 0.5	66 - 56	56 - 46
0.50 - 5.0	56	46
5.0 - 30.0	60	50

- Note:** (1) The lower limit shall apply at the transition frequencies.  
(2) The limit decreases in line with the logarithm of the frequency in the range of 0.15 to 0.50 MHz.

##### 3.1.2 TEST INSTRUMENTS

Equipment	Manufacturer	Model No.	Serial No.	Last Cal.	Next Cal.
EMI Test Receiver	Rohde&Schwarz	ESR7	101494	Mar. 21,18	Mar. 20,19
Artificial Mains Network	Rohde&Schwarz	ENV216	101173	Mar. 03,18	Mar. 02,19
Artificial Mains Network	Rohde&Schwarz	ESH3-Z5	100317	Apr. 11,18	Apr. 10,19
Voltage probe	SCHWARZBEC K	TK 9421	TK 9421-176	Jan. 17,18	Jan. 16,19
Test software	ADT	ADT_Cond_V 7.3.7	N/A	N/A	N/A

- NOTE:** 1. The test was performed in shielding Room 843.  
2. The calibration interval of the above test instruments is 12 months and the calibrations are traceable to CEPREI/CHINA, GRGT/CHINA and NIM/CHINA



### 3.1.3 TEST PROCEDURE

- a. The EUT was placed 0.4 meters from the conducting wall of the shielded room with EUT being connected to the power mains through a line impedance stabilization network (LISN). Other support units were connected to the power mains through another LISN. The two LISNs provide 50 Ohm/ 50uH of coupling impedance for the measuring instrument.
- b. Both lines of the power mains connected to the EUT were checked for maximum conducted interference.
- c. The frequency range from 150 kHz to 30 MHz was searched. Emission levels under (Limit – 20dB) were not recorded.

### 3.1.4 DEVIATION FROM TEST STANDARD

No deviation

### 3.1.5 TEST SETUP

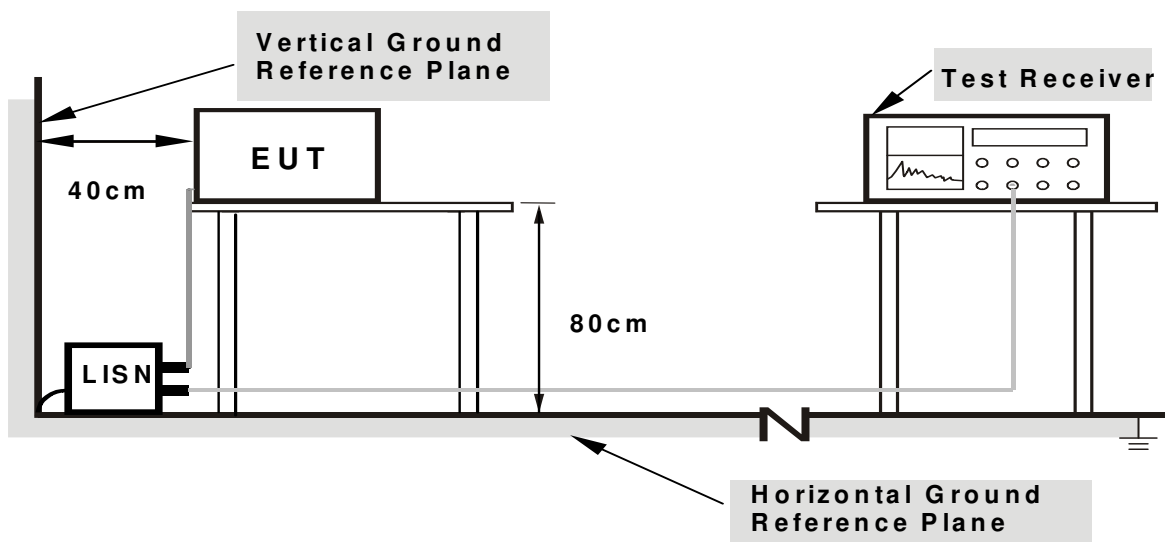

- Note:**
1. Support units were connected to second LISN.
  2. Both of LISNs (AMN) are 80cm from EUT and at least 80cm from other units and other metal planes support units.

### 3.1.6 EUT OPERATING CONDITIONS

- a. Turned on the power of all equipment.
- b. EUT was operated according to the type description in manufacturer's specifications or the User's Manual.



### 3.1.7 TEST RESULTS

<b>TEST MODE</b>	Battery charging from AC input	<b>6dB BANDWIDTH</b>	9 kHz
<b>TEST VOLTAGE</b>	AC230V/50Hz	<b>PHASE</b>	Line
<b>ENVIRONMENTAL CONDITIONS</b>	25 deg. C, 55% RH	<b>TESTED BY:</b> Jack	

No	Freq. [MHz]	Corr. Factor (dB)	Reading Value		Emission Level		Limit		Margin	
			[dB (uV)]		[dB (uV)]		[dB (uV)]		(dB)	
			Q.P.	AV.	Q.P.	AV.	Q.P.	AV.	Q.P.	AV.
1	0.15391	3.66	39.21	32.46	42.87	36.12	65.79	55.79	-22.92	-19.67
2	0.19297	7.70	31.08	27.66	38.78	35.36	63.91	53.91	-25.13	-18.55
3	0.27891	8.54	27.21	15.66	35.75	24.20	60.85	50.85	-25.10	-26.65
4	3.57031	9.23	31.57	30.82	40.80	40.05	56.00	46.00	-15.20	-5.95
5	4.42578	9.29	36.23	34.42	45.52	43.71	56.00	46.00	-10.48	-2.29
6	13.57031	9.48	39.57	38.24	49.05	47.72	60.00	50.00	-10.95	-2.28

**REMARKS:** The emission levels of other frequencies were very low against the limit.

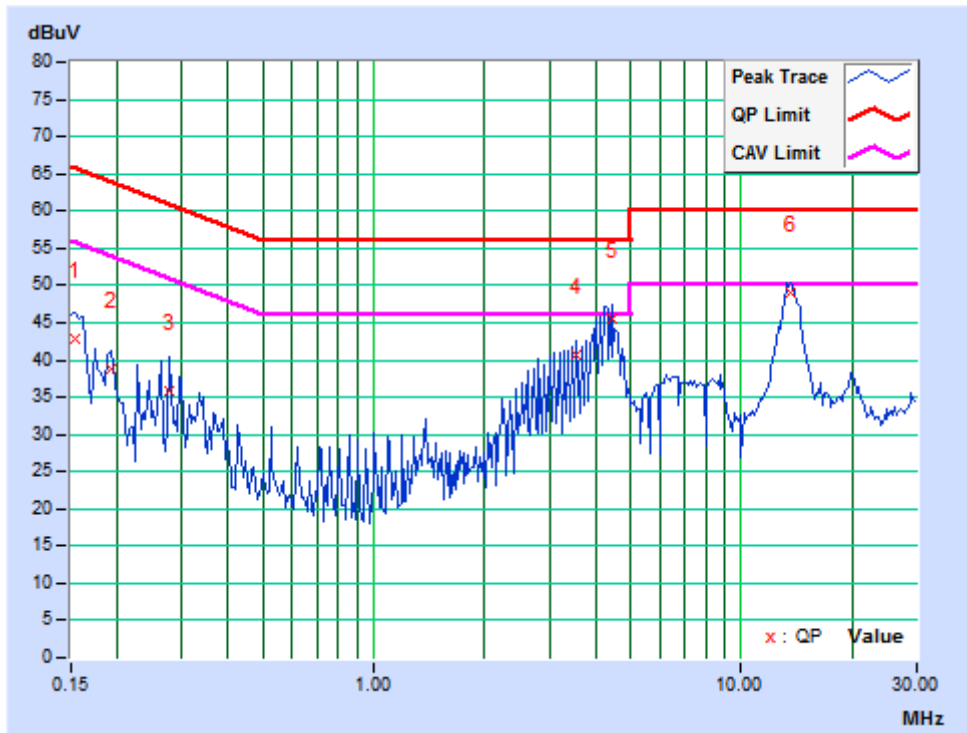

<b>TEST MODE</b>	Battery charging from AC input	<b>6dB BANDWIDTH</b>	9 kHz
<b>TEST VOLTAGE</b>	AC230V/50Hz	<b>PHASE</b>	Neutral (N)
<b>ENVIRONMENTAL CONDITIONS</b>	25 deg. C, 55% RH	<b>TESTED BY:</b> Jack	

No	Freq. [MHz]	Corr. Factor (dB)	Reading Value		Emission Level		Limit		Margin	
			[dB (uV)]		[dB (uV)]		[dB (uV)]		(dB)	
			Q.P.	AV.	Q.P.	AV.	Q.P.	AV.	Q.P.	AV.
1	0.15781	4.07	39.89	35.45	43.96	39.52	65.58	55.58	-21.62	-16.06
2	0.23594	8.40	25.98	19.85	34.38	28.25	62.24	52.24	-27.86	-23.99
3	0.27500	8.49	29.59	16.41	38.08	24.90	60.97	50.97	-22.89	-26.07
4	4.04688	9.26	25.76	25.18	35.02	34.44	56.00	46.00	-20.98	-11.56
5	8.90625	9.37	28.88	26.81	38.25	36.18	60.00	50.00	-21.75	-13.82
6	13.47656	9.49	35.70	34.48	45.19	43.97	60.00	50.00	-14.81	-6.03

**REMARKS:** The emission levels of other frequencies were very low against the limit.

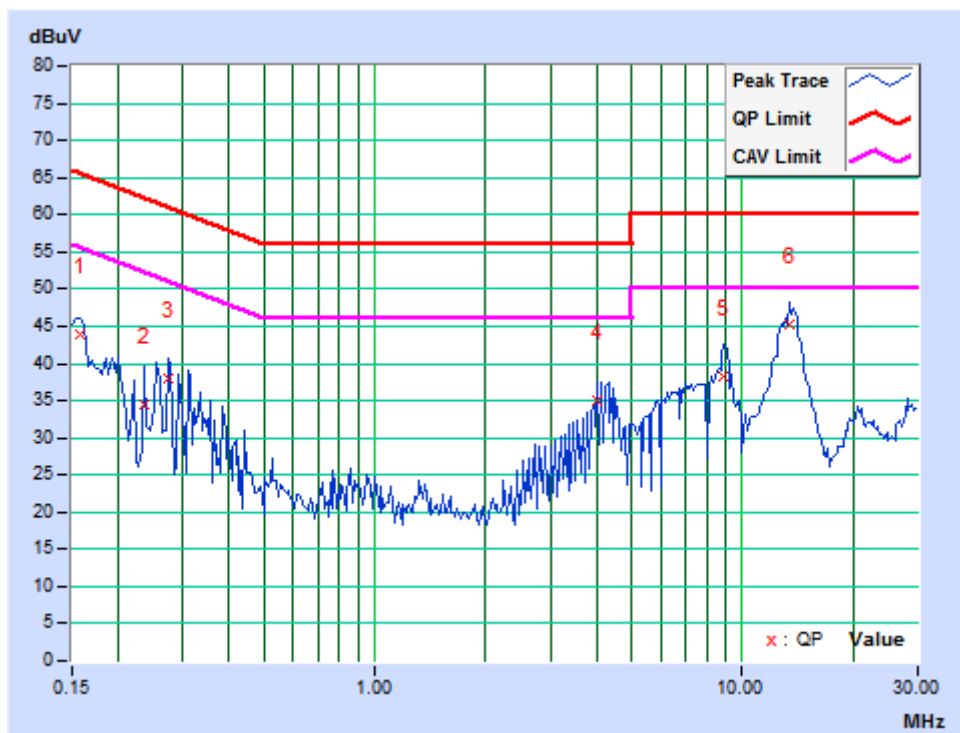



### 3.2 RADIATED EMISSION MEASUREMENT

#### 3.2.1 LIMITS OF RADIATED EMISSION MEASUREMENT

**TEST STANDARD: IEC 61000-6-3**

#### **FREQUENCY RANGE OF RADIATED MEASUREMENT (For unintentional radiators)**

Highest frequency generated or Upper frequency of measurement used in the device or on which the device operates or tunes (MHz)	Range (MHz)
Below 108	1000
108 – 500	2000
500 – 1000	5000
Above 1000	Up to 5 times of the highest frequency or 6 GHz, whichever is less

#### **FOR FREQUENCY BELOW 1000 MHz**

FREQUENCY (MHz)	3m	10m
	Quasi-Peak (dBuV/m)	Quasi-Peak (dBuV/m)
30 – 230	40	30
230 – 1000	47	37

#### **FOR FREQUENCY ABOVE 1000 MHz**

FREQUENCY (GHz)	3m	
	PEAK(dBuV/m)	AVERAGE(dBuV/m)
1 to 3	70	50
3 to 6	74	54

**NOTE:** (1) The lower limit shall apply at the transition frequencies.  
(2) Emission level (dBuV/m) = 20 log Emission level (uV/m).





### 3.2.2 TEST INSTRUMENTS

#### FOR FREQUENCY BELOW 1GHz

Equipment	Manufacturer	Model No.	Serial No.	Last Cal.	Next Cal.
EMI Test Receiver	Rohde&Schwarz	ESU26	100005	Aug. 24,18	Aug. 23,19
EMI Test Receiver	Rohde&Schwarz	ESR7	101564	Jan. 18,18	Jan. 17,19
Trilog-Broadband Antenna	SCHWARZBECK	VULB 9168	9168-555	Nov. 10, 17	Nov. 09, 18
Trilog-Broadband Antenna	SCHWARZBECK	VULB 9168	9168-554	Dec. 10, 17	Dec. 09, 18
Preamplifier	EMCI	EMC1135	980378	Mar. 19,18	Mar. 18,19
Preamplifier	EMCI	EMC1135	980423	Mar. 19,18	Mar. 18,19
10m Semi-anechoic Chamber	CHANGLING	21.4m*12.1m*8.8m	NSEMC006	Feb. 10,18	Feb. 09,19
Test Software	ADT	ADT_Radiated v8.7.07	N/A	N/A	N/A

- NOTES:** 1. The test was performed in 10m Chamber.  
2. The calibration interval of the above test instruments is 12 months. And the calibrations are traceable to CEPREI/CHINA, GRGT/CHINA and NIM/CHINA.

#### FREQUENCY RANGE ABOVE 1GHz

Equipment	Manufacturer	Model No.	Serial No.	Last Cal.	Next Cal.
Horn Antenna	ETS-Lindgren	3117	00085519	Dec. 10, 17	Dec. 09, 18
Horn Antenna	SCHWARZBECK	BBHA 9170	BBHA9170242	May 05,18	May 04,19
Signal and Spectrum Analyzer	Rohde&Schwarz	FSV40	101003	Apr. 21,18	Apr. 20,19
Broadband Preamplifier (1~18GHz)	SCHWARZBECK	BBV9718	266	Apr. 18,18	Apr. 18,19
Pre-Amplifier (18GHz-40GHz)	EMCI	EMC 184045	980102	Nov. 08,17	Nov. 07,18
Test Software	ADT	ADT_Radiated v8.7.07	N/A	N/A	N/A

- NOTES:** 1. The test was performed in 10m Chamber.  
2. The calibration interval of the above test instruments are 12 months. And the calibrations are traceable to CEPREI/CHINA, GRGT/CHINA and NIM/CHINA.



### 3.2.3 TEST PROCEDURE

#### <Frequency Range below 1GHz>

- a. The EUT was placed on the top of a rotating table 0.8 meters above the ground at a 10 meter chamber room. The table was rotated 360 degrees to determine the position of the highest radiation.
- b. The EUT was set 10 meters away from the interference-receiving antenna, which was mounted on the top of a variable-height antenna tower.
- c. The height of antenna is varied from one meter to four meters above the ground to determine the maximum value of the field strength. Both horizontal and vertical polarizations of the antenna are set to make the measurement.
- d. For each suspected emission, the EUT was arranged to its worst case and then the antenna was tuned to heights from 1 meter to 4 meters and the turn table was turned from 0 degrees to 360 degrees to find the maximum reading.
- e. The test-receiver system was set to quasi-peak detect function and specified bandwidth with maximum hold mode when the test frequency is below 1 GHz.

#### NOTE:

1. The resolution bandwidth of test receiver/spectrum analyzer is 120kHz for Quasi-peak detection (QP) at frequency below 1GHz.
2. Emission level(dBuV/m)=Raw Value(dBuV) + Correction Factor(dB/m)
3. Correction Factor(dB/m) = Antenna Factor (dB/m) + Cable Factor (dB) (if the raw value not contains the amplifier);
4. Correction Factor(dB/m) = Antenna Factor (dB/m) + Cable Factor (dB) – Amplifier Gain(dB) (if the raw value contains the amplifier).
5. Margin value = Emission level – Limit value.



### <Frequency Range above 1GHz>

- a. The EUT was placed on the top of a rotating table 0.8 meters above the ground at a 10 meter Semi-anechoic chamber room. The table was rotated 360 degrees to determine the position of the highest radiation.
- b. The EUT was set 3 meters away from the interference-receiving antenna, which was mounted on the top of a variable-height antenna tower.
- c. The height of antenna can be varied from one meter-to four meters, the height of adjustment depends on the EUT height and the antenna 3dB beamwidth both, to detect the maximum value of the field strength. Both horizontal and vertical polarizations of the antenna are set to make the measurement. The bore sight should be used during the test above 1GHz.
- d. For each suspected emission, the EUT was arranged to its worst case and then the antenna was tuned to heights and the rotatable table was turned from 0 degrees to 360 degrees to find the maximum reading.
- e. The test receiver/spectrum was set to peak and average detect function and specified bandwidth with maximum hold mode when the test frequency is above 1 GHz.

#### NOTE:

1. The resolution bandwidth is 1MHz and video bandwidth of test receiver/spectrum analyzer is 3MHz for Peak detection at frequency above 1GHz. The resolution bandwidth of test receiver/spectrum analyzer is 1 MHz for Average detection (AV) at frequency above 1GHz.
2. For measurement of frequency above 1000 MHz, the EUT was set 3 meters away from the receiver antenna.
3. Emission level(dBuV/m)=Raw Value(dBuV) + Correction Factor(dB/m)
4. Correction Factor (dB/m) = Antenna Factor (dB/m) + Cable Factor (dB) (if the raw value not contains the amplifier).
5. Correction Factor (dB/m) = Antenna Factor (dB/m) + Cable Factor (dB) – Amplifier Gain (dB) (if the raw value contains the amplifier).
6. Margin value = Emission level – Limit value.

### 3.2.4 DEVIATION FROM TEST STANDARD

No deviation



### 3.2.5 TEST SETUP

<Frequency Range below 1GHz>

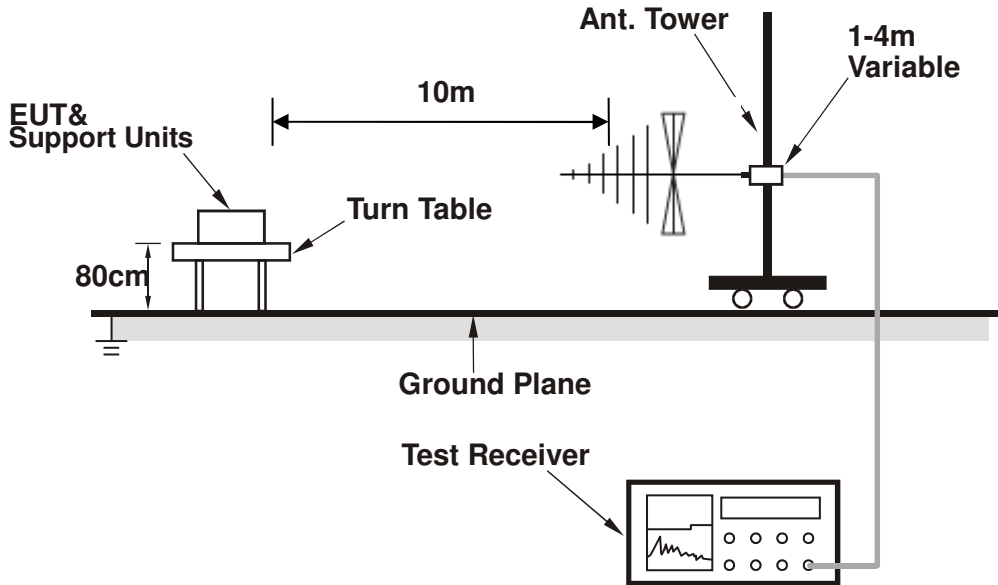

<Frequency Range above 1GHz>

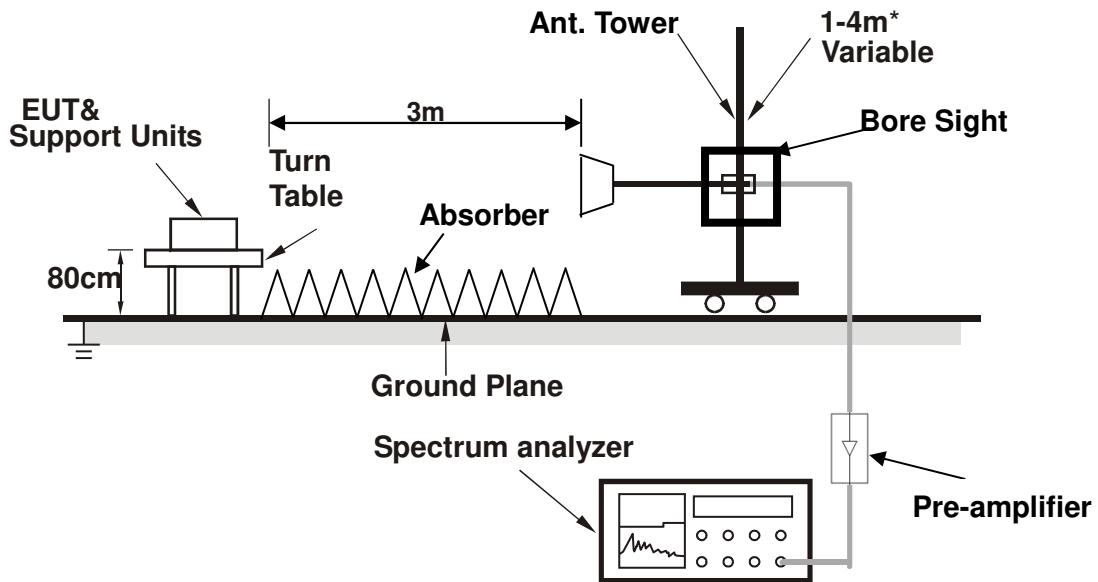

\* :depends on the EUT height and the antenna 3dB beamwidth both, refer to section 7.3 of CISPR 16-2-3.

### 3.2.6 EUT OPERATING CONDITIONS

Same as item 3.1.6



### 3.2.7 TEST RESULTS

<b>TEST MODE</b>	Battery charging from AC input	<b>FREQUENCY RANGE</b>	30-1000 MHz
<b>TEST VOLTAGE</b>	AC230V/50Hz	<b>DETECTOR FUNCTION &amp; BANDWIDTH</b>	Quasi-Peak, 120kHz
<b>ENVIRONMENTAL CONDITIONS</b>	23 deg. C, 67% RH	<b>TESTED BY:</b> Luke	

ANTENNA POLARITY & TEST DISTANCE: HORIZONTAL AT 10 M								
No.	Freq. (MHz)	Correction Factor (dB/m)	Raw Value (dBuV)	Emission Level (dBuV/m)	Limit (dBuV/m)	Margin (dB)	Antenna Height (cm)	Table Angle (Degree)
1	43.944	-17.32	35.01	17.69	30.00	-12.31	400	145
2	54.856	-17.83	35.40	17.57	30.00	-12.43	200	329
3	135.973	-18.11	31.92	13.81	30.00	-16.19	400	154
4	167.255	-17.22	34.58	17.36	30.00	-12.64	400	150
5	232.366	-17.85	35.14	17.29	37.00	-19.71	400	81
6	292.991	-15.55	35.54	19.99	37.00	-17.01	400	3

- REMARKS:**
1. Peak detector quick scan is showed on the graph and final quasi-peak detector data is measured corresponding to relevant limit and recorded in the data table.
  2. Negative sign (-) in the margin column signify levels below the limit.
  3. Frequency range scanned: 30MHz to 1000MHz.
  4. Only emissions significantly above equipment noise floor are reported

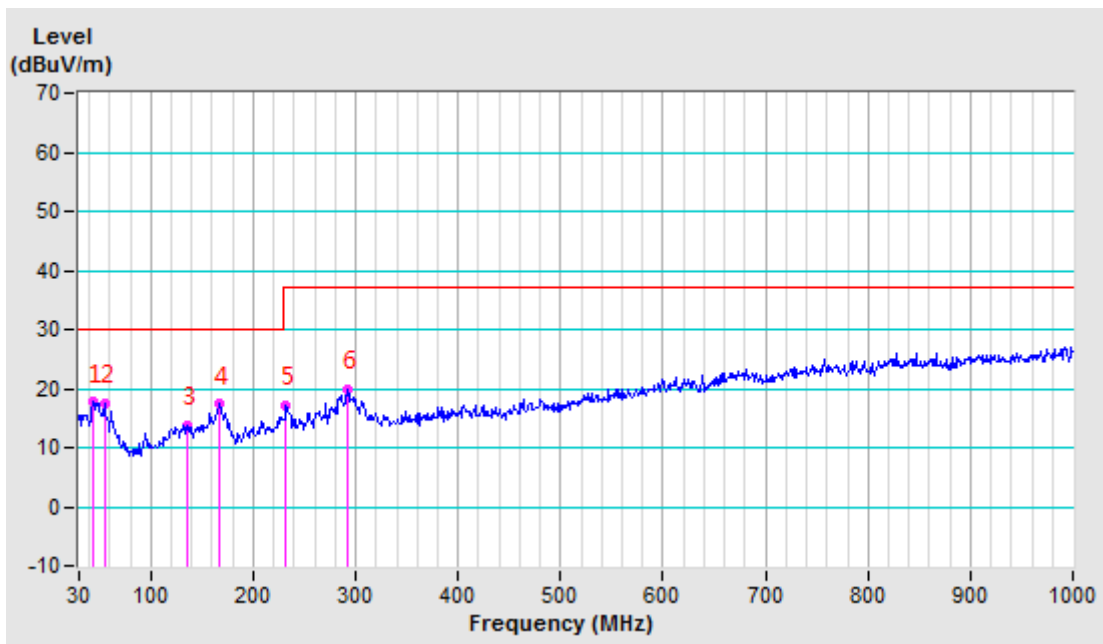

<b>TEST MODE</b>	Battery charging from AC input	<b>FREQUENCY RANGE</b>	30-1000 MHz
<b>TEST VOLTAGE</b>	AC230V/50Hz	<b>DETECTOR FUNCTION &amp; BANDWIDTH</b>	Quasi-Peak, 120kHz
<b>ENVIRONMENTAL CONDITIONS</b>	23 deg. C, 67% RH	<b>TESTED BY:</b> Luke	

<b>ANTENNA POLARITY &amp; TEST DISTANCE: VERTICAL AT 10 M</b>								
No.	Freq. (MHz)	Correction Factor (dB/m)	Raw Value (dBuV)	Emission Level (dBuV/m)	Limit (dBuV/m)	Margin (dB)	Antenna Height (cm)	Table Angle (Degree)
1	30.000	-19.01	48.41	29.40	30.00	-0.60	100	124
2	44.784	-17.91	46.61	28.70	30.00	-1.30	100	125
3	62.497	-19.37	44.47	25.10	30.00	-4.90	100	98
4	87.718	-21.65	39.93	18.28	30.00	-11.72	100	73
5	170.027	-16.63	35.07	18.44	30.00	-11.56	100	124
6	260.726	-15.95	38.30	22.35	37.00	-14.65	100	301

- REMARKS:**
1. Peak detector quick scan is showed on the graph and final quasi-peak detector data is measured corresponding to relevant limit and recorded in the data table.
  2. Negative sign (-) in the margin column signify levels below the limit.
  3. Frequency range scanned: 30MHz to 1000MHz.
  4. Only emissions significantly above equipment noise floor are reported

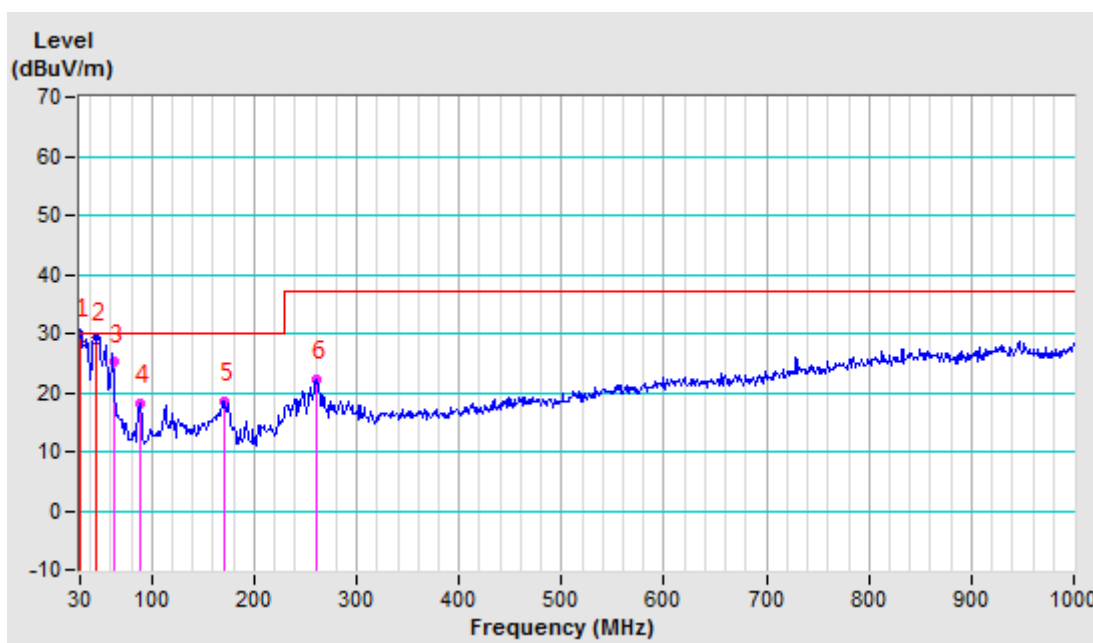

### 3.3 HARMONICS CURRENT MEASUREMENT

#### 3.3.1 TEST INSTRUMENTS

TEST STANDARD: IEC 61000-3-2 and IEC 61000-3-12

DESCRIPTION & MANUFACTURER	MANUFACTURER	MODEL NO.	SERIAL NO.	CALIBRATED DATE	CALIBRATED UNTIL
PRECISION POWER ANALYZER	YOKOGAWA	WT3000	91M210852	Mar. 10,18	Mar. 11,19
Test Software	YOKOGAWA	IEC61000	N/A	N/A	N/A
REFERENCE IMPEDANCE NETWORK	Voltech	EUR	3018	Apr. 08,18	Apr. 09,19

- NOTE:** 1. The test was performed in PV Room.  
 2. The calibration interval of the above test instruments is 12 months and the calibrations are traceable to CEPREI/CHINA and NIM/CHINA.

#### 3.3.2 DEVIATION FROM TEST STANDARD

No deviation

#### 3.3.3 TEST SETUP

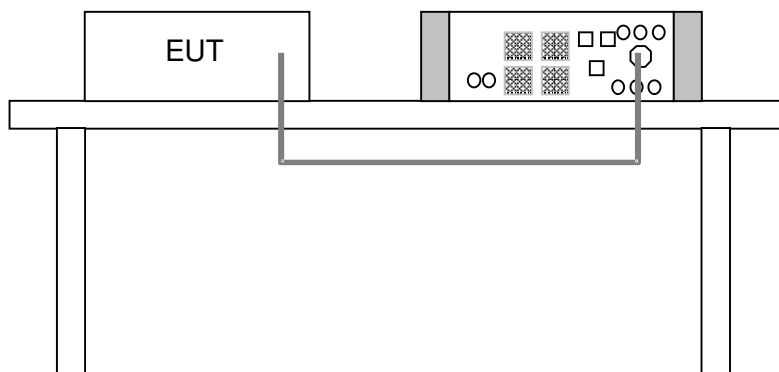

#### 3.3.4 EUT OPERATING CONDITIONS

Same as item 3.1.6



### 3.3.5 TEST RESULTS

#### FOR MODEL HYD 3000-ES

#### Average

Regulation : IEC61000-3-2 Ed3.0 am2  
 IEC61000-4-7 Ed2.0 A1  
 Class : CLASS A  
 MeasureTime : 149.80sec  
 Model : YOKOGAWA WT3000  
 Rating Voltage : 230.00 V  
 Wiring : single-phase 2-wire  
 Element : 1  
 Range : 300V/30A  
 Current(rms) : 13.4895 A  
 Voltage(rms) : 230.54 V  
 Frequency : 50.000 Hz  
 Power Factor : 0.9933  
 POHC Limit : 0.2514 A  
 POHC Max : 0.0441 A  
 THC : 0.2281 A

PASS

Set Fundamental I : -----  
 Set Power Factor : -----  
 Set P : -----  
 Sigma W Max : 3091.754 W  
 Sigma PF : 0.9933  
 Distortion factor(V) : 0.05 %  
 V THDS : 0.05 %  
 V THDG : 0.05 %  
 Distortion factor(A) : 1.61 %  
 A THDS : 1.65 %  
 A THDG : 1.69 %  
 P THD : 0.00 %  
 Power Limit : 75 W

Order	Measure[A]	Limit[A]	Margin[%]	Order	Measure[A]	Limit[A]	Margin[%]
1	13.4876			2	0.0265	1.0800	97.5
3	0.1968	2.3000	91.4	4	0.0206	0.4300	95.2
5	0.0733	1.1400	93.6	6	0.0155	0.3000	94.8
7	0.0451	0.7700	94.1	8	0.0132	0.2300	94.3
9	0.0260	0.4000	93.5	10	0.0110	0.1840	94.0
11	0.0159	0.3300	95.2	12	0.0083	0.1533	94.6
13	0.0144	0.2100	93.1	14	0.0069	0.1314	94.7
15	0.0139	0.1500	90.7	16	0.0063	0.1150	94.5
17	0.0143	0.1324	89.2	18	0.0057	0.1022	94.4
19	0.0159	0.1184	86.6	20	0.0053	0.0920	94.3
21	0.0158	0.1071	85.2	22	0.0056	0.0836	93.3
23	0.0152	0.0978	84.5	24	0.0055	0.0767	92.8
25	0.0156	0.0900	82.6	26	0.0137	0.0708	80.6
27	0.0147	0.0833	82.4	28	0.0051	0.0657	92.2
29	0.0137	0.0776	82.3	30	0.0046	0.0613	92.5
31	0.0129	0.0726	82.2	32	0.0045	0.0575	92.2
33	0.0119	0.0682	82.5	34	0.0046	0.0541	91.5
35	0.0118	0.0643	81.6	36	0.0044	0.0511	91.3
37	0.0118	0.0608	80.6	38	0.0044	0.0484	91.0
39	0.0105	0.0577	81.9	40	0.0044	0.0460	90.3

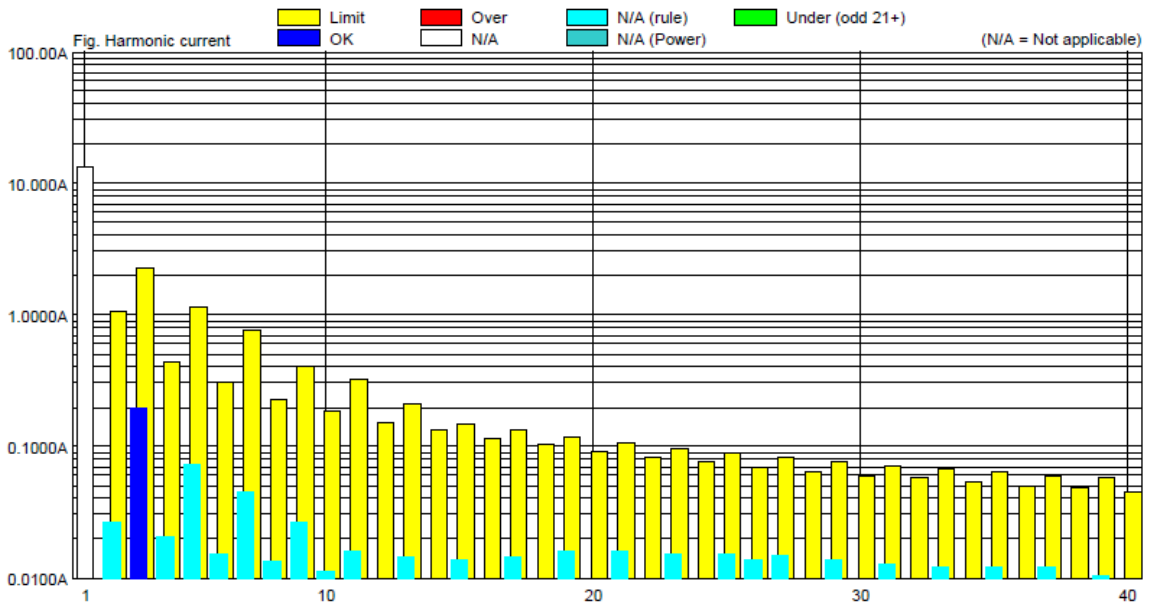



**Maximum**

Regulation : IEC61000-3-2 Ed3.0 am2  
 IEC61000-4-7 Ed2.0 A1  
 Class : CLASS A  
 MeasureTime : 149.80sec  
 Model : YOKOGAWA WT3000  
 Rating Voltage : 230.00 V  
 Wiring : single-phase 2-wire  
 Element : 1  
 Range : 300V/30A  
 Current(rms) : 13.5022 A  
 Voltage(rms) : 230.54 V  
 Frequency : 50.007 Hz  
 Power Factor : 0.9934  
 Beyond Limit Time : 14.9801 s  
 Beyond Total Time : 0.0000 s  
 THC : 0.2303 A

**PASS**

Set Fundamental I : -----  
 Set Power Factor : -----  
 Set P : -----  
 Sigma W Max : 3091.754 W  
 Sigma PF : 0.9934  
 Distortion factor(V) : 0.05 %  
 V THDS : 0.05 %  
 V THDG : 0.05 %  
 Distortion factor(A) : 1.69 %  
 A THDS : 1.72 %  
 A THDG : 1.76 %  
 P THD : 0.00 %  
 Power Limit : 75 W

Order	Measure[A]	Limit[A]	Margin[%]	Order	Measure[A]	Limit[A]	Margin[%]
1	13.5002			2	0.0288	1.6200	98.2
3	0.1986	3.4500	94.2	4	0.0221	0.6450	96.6
5	0.0750	1.7100	95.6	6	0.0170	0.4500	96.2
7	0.0468	1.1550	96.0	8	0.0154	0.3450	95.5
9	0.0280	0.6000	95.3	10	0.0132	0.2760	95.2
11	0.0186	0.4950	96.2	12	0.0106	0.2300	95.4
13	0.0165	0.3150	94.8	14	0.0088	0.1971	95.5
15	0.0153	0.2250	93.2	16	0.0078	0.1725	95.5
17	0.0154	0.1985	92.2	18	0.0068	0.1533	95.6
19	0.0169	0.1776	90.5	20	0.0064	0.1380	95.4
21	0.0169	0.1607	89.5	22	0.0069	0.1255	94.5
23	0.0161	0.1467	89.0	24	0.0066	0.1150	94.2
25	0.0168	0.1350	87.5	26	0.0159	0.1062	...
27	0.0155	0.1250	87.6	28	0.0059	0.0986	94.1
29	0.0146	0.1164	87.5	30	0.0053	0.0920	94.3
31	0.0137	0.1089	87.5	32	0.0051	0.0862	94.1
33	0.0127	0.1023	87.6	34	0.0051	0.0812	93.7
35	0.0127	0.0964	86.9	36	0.0050	0.0767	93.5
37	0.0126	0.0912	86.2	38	0.0049	0.0726	93.2
39	0.0112	0.0865	87.0	40	0.0050	0.0690	92.7

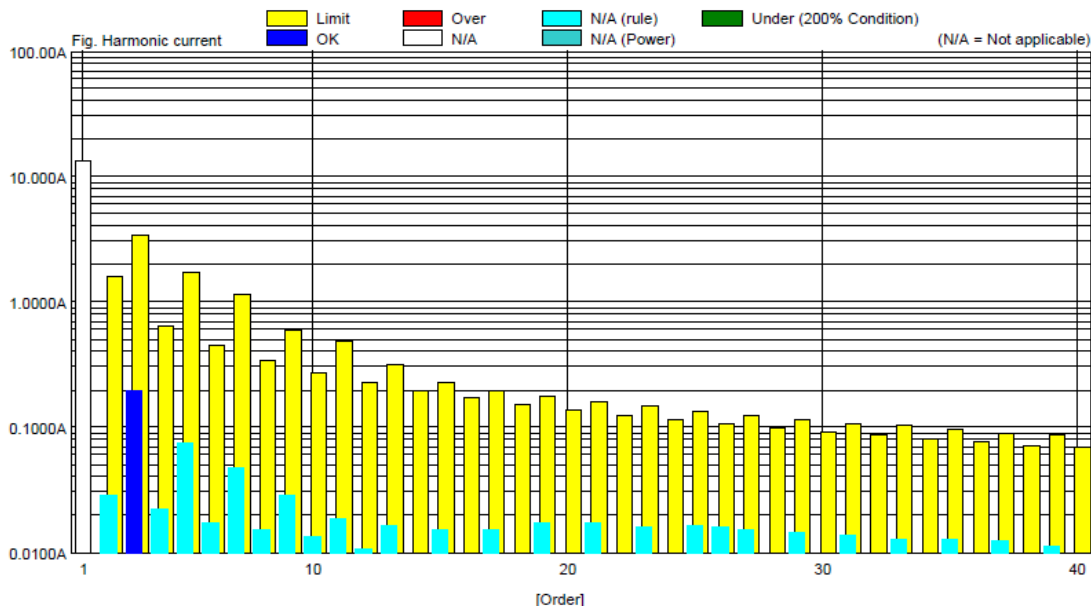



**FOR MODEL HYD 6000-ES**

Regulation : IEC61000-3-12  
 IEC61000-4-7 Ed2.0 A1  
 MeasureTime : 150sec  
 Model : YOKOGAWA WT3000  
 Wiring : single-phase 2-wire  
 Element : 1  
 Range : 300V/400.0A  
 Rating Voltage : 230 V  
 I<sub>eq</sub> : 15.0000 A  
 Z Impedance : 0.1200 ohm  
 I<sub>1</sub> : 25.7299 A  
 Power Rsce : 127.778  
 Max Rsce : 33.000

**PASS**

Ssc : 341550.00  
 Min Rsce : 33.0000  
 Apply Limit : equipment other than balanced 3-phase.  
 Situation1 : 0.94% (Pass)  
 Term a : 4.04 - 69.42deg (Fail)  
 Term c(I5) : 0.21% (Pass)  
 Term c(I7) : 0.22% (Pass)

[Average]  
 Voltage(rms) : 230.89 V  
 Current(rms) : 25.73 A  
 Frequency : 50.00 Hz  
 Power Factor : 1.00  
 Sigma W : 5925.18 W  
 THC : 0.29 A  
 V THD : 0.04 %  
 A THD : 1.14 %  
 P THD : 0.00 %

[Maximum]  
 Voltage(rms) : 230.90 V  
 Current(rms) : 25.76 A  
 Frequency : 50.01 Hz  
 Power Factor : 1.00  
 Sigma W : 5930.65 W  
 THC : 0.30 A  
 V THD : 0.04 %  
 A THD : 1.25 %  
 P THD : 0.00 %

Order	Measure[%]	Limit[%]	Margin[%]
2	0.2068	8.0000	97.4
3	0.9250	21.9800	95.8
4	0.1675	4.0000	95.8
5	0.1950	11.3200	98.3
6	0.1452	2.6667	94.6
7	0.2097	7.3250	97.1
8	0.1137	2.0000	94.3
9	0.1265	3.8250	96.7
10	0.0774	1.6000	95.2
11	0.1520	3.1600	95.2
12	0.0899	1.3333	93.3
13	0.0925	2.0600	95.5
THD	1.1381	23.4750	95.2
PWHD	2.1239	23.4750	91.0

Order	Measure[%]	Limit[%]	Margin[%]
2	0.2174	12.0000	98.2
3	0.9413	32.9700	97.1
4	0.1761	6.0000	97.1
5	0.2101	16.9800	98.8
6	0.1532	4.0000	96.2
7	0.2242	10.9875	98.0
8	0.1264	3.0000	95.8
9	0.1398	5.7375	97.6
10	0.0917	2.4000	96.2
11	0.1665	4.7400	96.5
12	0.1081	2.0000	94.6
13	0.1079	3.0900	96.5
THD	1.1886	35.2125	96.6
PWHD	2.3691	35.2125	93.3

Limit (Yellow) Limit Over (Red)  
 OK (Blue) N/A (White)  
 N/A (rule) (Cyan)

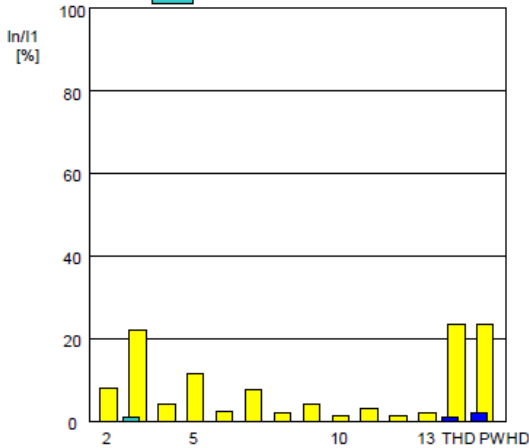

Limit (Yellow) Limit Over (Red)  
 OK (Blue) N/A (White)  
 N/A (rule) (Cyan)

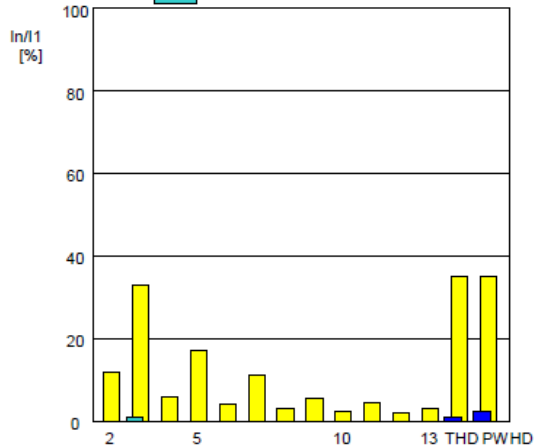



### 3.4 VOLTAGE FLUCTUATION AND FLICKS MEASUREMENT

TEST STANDARD: IEC 61000-3-3 and IEC 61000-3-11

#### 3.4.1 TEST INSTRUMENTS

DESCRIPTION & MANUFACTURER	MANUFACTURER	MODEL NO.	SERIAL NO.	CALIBRATED DATE	CALIBRATED UNTIL
PRECISION POWER ANALYZER	YOKOGAWA	WT3000	91M210852	Mar. 07, 2018	Mar. 06, 2019
Test Software	YOKOGAWA	IEC61000	N/A	N/A	N/A
REFERENCE IMPEDANCE NETWORK	Voltech	EUR	3018	N/A	N/A

**NOTE:** 1. The test was performed in PV Room.  
 2. The calibration interval of the above test instruments is 12 months and the calibrations are traceable to CEPREI/CHINA and NIM/CHINA

#### 3.4.2 TEST PROCEDURE

- a. The EUT was placed on the top of a wooden table 0.8 meters above the ground and operated to produce the most unfavorable sequence of voltage changes under Normal Operating conditions.
- b. During the flick measurement, the measure time shall include that part of whole operation cycle in which the EUT produce the most unfavorable sequence of voltage changes. The observation period for short-term flicker indicator is 120 minutes

#### 3.4.3 DEVIATION FROM TEST STANDARD

No deviation

#### 3.4.4 TEST SETUP

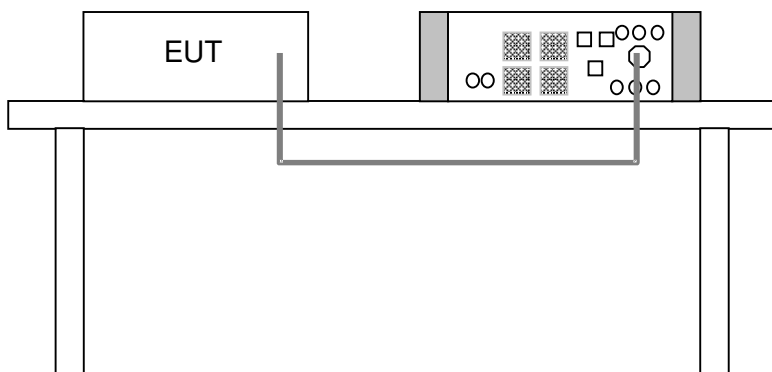

#### 3.4.5 EUT OPERATING CONDITIONS

Same as item 3.1.6



### 3.4.6 TEST RESULTS

#### FOR MODEL HYD 3000-ES

Regulation : IEC61000-3-3 Ed2.0  
 IEC61000-4-15 Ed1.1  
 Interval : 10Min0Sec  
 Model : YOKOGAWA WT3000  
 Wiring : single-phase 2wire  
 Voltage Range : 300.00V  
 Voltage U1 : 235.60V  
 Set Frequency : 50Hz  
 Frequency U1 : 49.999Hz  
 Element : 1  
 dmin : 0.10%

**PASS**

Element1 : Pass  
 dc (3.30%) : Pass  
 dmax (4.00%) : Pass  
 d(t) (500ms) : Pass  
 Pst (1.00) : Pass  
 Plt (0.65) : Pass

No.	dc[%]	dmax[%]	d(t)[ms]	Pst
1	0.05	0.14	0.00	0.14
2	0.00	0.00	0.00	0.14
3	0.00	0.00	0.00	0.14
4	0.00	0.00	0.00	0.14
5	0.00	0.00	0.00	0.14
6	0.00	0.00	0.00	0.14
7	0.00	0.00	0.00	0.14
8	0.00	0.00	0.00	0.14
9	0.00	0.00	0.00	0.14
10	0.00	0.00	0.00	0.14
11	0.00	0.00	0.00	0.14
12	0.00	0.00	0.00	0.14

Plt  
0.14

#### FOR MODEL HYD 6000-ES

Regulation : IEC61000-3-11 Ed1.0  
 IEC61000-4-15 Ed1.1  
 Interval : 10Min0Sec  
 Model : YOKOGAWA WT3000  
 Wiring : single-phase 2wire  
 Voltage Range : 300.00V  
 Voltage U1 : 239.95V  
 Set Frequency : 50Hz  
 Frequency U1 : 50.000Hz  
 Element : 1  
 dmin : 0.10%

**PASS**

Compatibility Condition : Compliance with IEC61000-3-3  
 Element1 : Pass  
 dc (3.30%) : Pass  
 dmax (4.00%) : Pass  
 d(t) (500ms) : Pass  
 Pst (1.00) : Pass  
 Plt (0.65) : Pass

No.	dc[%]	dmax[%]	d(t)[ms]	Pst
1	0.11	0.24	0.00	0.25
2	1.17	1.29	0.00	0.35
3	0.07	1.25	0.00	0.36
4	0.05	1.25	0.00	0.36
5	0.39	1.25	0.00	0.36
6	0.35	1.24	0.00	0.36
7	0.07	1.26	0.00	0.36
8	0.39	1.26	0.00	0.36
9	0.06	1.26	0.00	0.36
10	0.38	1.23	0.00	0.36
11	0.37	1.26	0.00	0.36
12	0.05	1.28	0.00	0.36

Plt  
0.35



## 4 IMMUNITY TEST

### 4.1 GENERAL DESCRIPTION

#### 4.1.1 GENERAL DESCRIPTION OF IEC 61000-6-2

<b>Product Standard:</b>	<b>IEC 61000-6-2:2016</b>	
<b>Basic Standard, specification requirement, and Performance Criteria:</b>	IEC 61000-4-2	Electrostatic Discharge – ESD: 4kV Contact discharge, 8kV air discharge, Performance Criterion B
	IEC 61000-4-3	Radio-Frequency Electromagnetic Field Susceptibility Test – RS: 80-1000 MHz, 10V/m, 80% AM (1kHz), 1400-2000 MHz, 3V/m, 80% AM (1kHz) 2000-2700 MHz, 1V/m, 80% AM (1kHz) Performance Criterion A
	IEC 61000-4-4	Electrical Fast Transient/Burst - EFT AC Power line: 2kV, DC Power line: 2kV Signal line: 1kV Performance Criterion B
	IEC 61000-4-5	Surge Immunity Test: 1.2/50 us Open Circuit Voltage, 8 /20 us Short Circuit Current, AC Power Line: line to line 1 kV, line to earth 2kV DC Power Line: line to line 0.5kV line to earth 0.5kV Signal line: 1kV Performance Criterion B
	IEC 61000-4-6	Conducted Radio Frequency Disturbances Test – CS: 0.15-80 MHz, 10Vrms, 80% AM, 1kHz, Performance Criterion A
	IEC 61000-4-8	Power Frequency Magnetic Field Test, 50 Hz, 30A/m, Performance Criterion A



### 4.1.2 PERFORMANCE CRITERIA

According to Clause 4 of IEC 61000-6-2:2016 standard, the following describes the general performance criteria.

<b>CRITERION A</b>	The apparatus shall continue to operate as intended during and after the test. No degradation of performance or loss of function is allowed below a performance level specified by the manufacturer, when the apparatus is used as intended. The performance level may be replaced by a permissible loss of performance. If the minimum performance level or the permissible performance loss is not specified by the manufacturer, either of these may be derived from the product description and documentation and what the user may reasonably expect from the apparatus if used as intended.
<b>CRITERION B</b>	The apparatus shall continue to operate as intended after the test. No degradation of performance or loss of function is allowed below a performance level specified by the manufacturer, when the apparatus is used as intended. The performance level may be replaced by a permissible loss of performance. During the test, degradation of performance is however allowed. No change of actual operating state or stored data is allowed. If the minimum performance level or the permissible performance loss is not specified by the manufacturer, either of these may be derived from the product description and documentation and what the user may reasonably expect from the apparatus if used as intended.
<b>CRITERION C</b>	Temporary loss of function is allowed, provided the function is self-recoverable or can be restored by the operation of the controls.

### 4.1.3 EUT OPERATING CONDITION

Same as item 3.1.6



## 4.2 ELECTROSTATIC DISCHARGE IMMUNITY TEST (ESD)

### 4.2.1 TEST SPECIFICATION

<b>Basic Standard:</b>	IEC 61000-4-2
<b>Discharge Impedance:</b>	330 ohm / 150 pF
<b>Discharge Voltage:</b>	Air Discharge: 8 kV (Direct) Contact Discharge: 4 kV (Indirect)
<b>Polarity:</b>	Positive & Negative
<b>Number of Discharge:</b>	20 times at each test point
<b>Discharge Mode:</b>	Single Discharge
<b>Discharge Period:</b>	1 second

### 4.2.2 TEST INSTRUMENTS

Equipment	Manufacturer	Model No.	Serial No.	Last Cal.	Next Cal.
ESD Generator	TESEQ	NSG 437	279	Mar. 31,18	Mar. 30,19
Test Software	TESEQ	V03.03	N/A	N/A	N/A
ESD Generator	EM TEST	Dito	V1211112265	Jan. 16,18	Jan. 15,19
Test Software	EM TEST	V 2.31	N/A	N/A	N/A

- NOTE:** 1. The test was performed in ESD Room.  
2. The calibration interval of the above test instruments is 12 months and the calibrations are traceable to CEPREI/CHINA, GRGT/CHINA and NIM/CHINA.



### 4.2.3 TEST PROCEDURE

The basic test procedure was in accordance with IEC 61000-4-2:

- a. Electrostatic discharges were applied only to those points and surfaces of the EUT that are accessible to users during normal operation.
- b. The test was performed with at least ten single discharges on the pre-selected points in the most sensitive polarity.
- c. The time interval between two successive single discharges was at least 1 second.
- d. The discharge return cable of the generator shall be kept at a distance of at least 0.2 m from the EUT whilst the discharge is being applied and should not be held by the operator.
- e. Contact discharges were applied to the non-insulating coating, with the pointed tip of the generator penetrating the coating and contacting the conducting substrate.
- f. Air discharges were applied with the round discharge tip of the discharge electrode approaching the EUT as fast as possible (without causing mechanical damage) to touch the EUT. After each discharge, the ESD generator was removed from the EUT and re-triggered for a new single discharge. The test was repeated until all discharges were complete.
- g. At least ten single discharges (in the most sensitive polarity) were applied to the **Horizontal Coupling Plane** at points on each side of the EUT. The ESD generator was positioned horizontal at a distance of 0.1 meters from the EUT with the discharge electrode touching the **HCP**.
- h. At least ten single discharges (in the most sensitive polarity) were applied to the center of one vertical edge of the **Vertical Coupling Plane** in sufficiently different positions that the four faces of the EUT were completely illuminated. The **VCP** (dimensions 0.5m x 0.5m) was placed vertically to and 0.1 meters from the EUT.

### 4.2.4 DEVIATION FROM TEST STANDARD

No Deviation







### 4.2.6 TEST RESULTS

<b>TEST MODE</b>	See items 2.2	<b>TEST VOLTAGE</b>	See items 2.2
<b>ENVIRONMENTAL CONDITIONS</b>	24.3deg. C, 43.8% RH 101.5kPa	<b>TESTED BY:</b> Hu	

Direct Discharge Application				
Test Level (kV)	Polarity	Test Point	Test Result of Contact Discharge	Test Result of Air Discharge
4	+/-	All Metal Part	A	N/A
8	+/-	All Non-metal Part	N/A	A

Indirect Discharge Application				
Discharge Level (kV)	Polarity	Test Point	Test Result of HCP	Test Result of VCP
4	+/-	HCP	A	N/A
4	+/-	VCP	N/A	A

**NOTE:** A: There was no change compared with initial operation during the test.

( ○ - Direct Contact Discharge;    -Air Discharge)

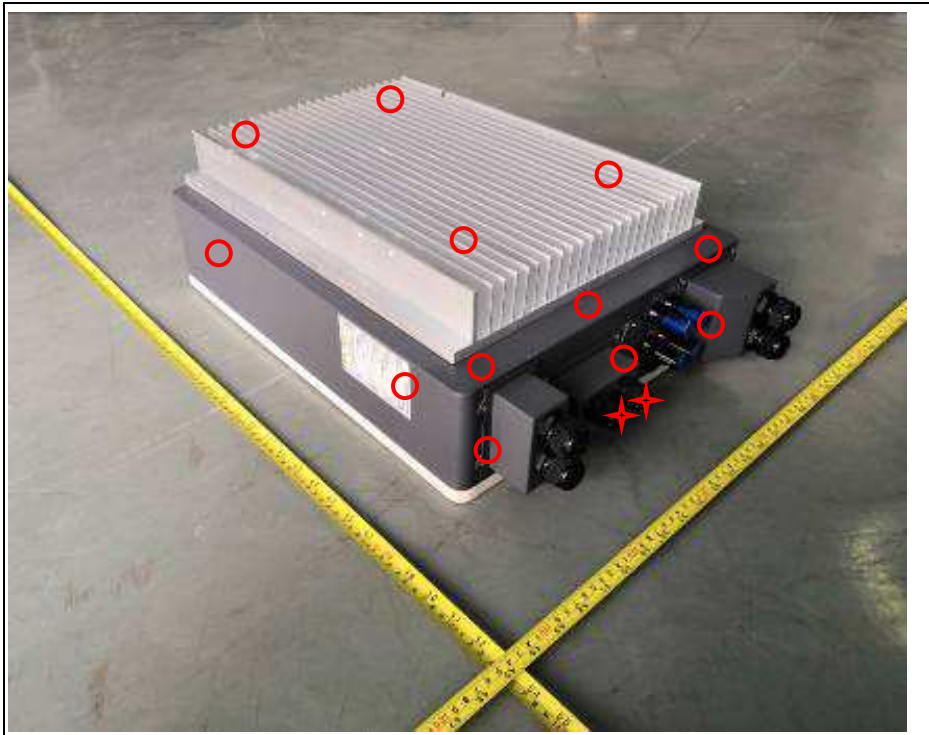



## 4.3 RADIATED, RADIO-FREQUENCY, ELECTROMAGNETIC FIELD IMMUNITY TEST (RS)

### 4.3.1 TEST SPECIFICATION

<b>Basic Standard:</b>	IEC 61000-4-3
<b>Frequency Range:</b>	80-1000MHz, 1400-2000MHz, 2000-2700MHz
<b>Field Strength:</b>	10V/m, 3V/m, 1V/m
<b>Modulation:</b>	1kHz Sine Wave, 80%, AM Modulation
<b>Frequency Step:</b>	1 % of fundamental
<b>Polarity of Antenna:</b>	Horizontal and Vertical
<b>Antenna Height:</b>	1.5m
<b>Dwell Time:</b>	at least 3 seconds

### 4.3.2 TEST INSTRUMENTS

Equipment	Manufacturer	Model No.	Serial No.	Last Cal.	Next Cal.
Signal Generator	Agilent	N5181A	MY50142530	Oct. 20,17	Oct. 19,18
Antenna Log-Periodic	AR	ATR80M6G	0337307	N/A	N/A
Antenna Log-Periodic	AR	ATS700M11G	0336821	N/A	N/A
Switch Controller	AR	SC1000	0337343	N/A	N/A
RF Power Meter	ESE	4242	13984	Jan. 02,18	Jan. 01,19
Power Sensor	ESE	51011EMC	35716	Jan. 02,18	Jan. 01,19
Power Sensor	ESE	51011EMC	35715	Jan. 02,18	Jan. 01,19
E-Field probe	Narda	NBM-520	2403/01B	Sep. 28,18	Sep. 27,19
Power Amplifier	TESEQ	CBA 1G-150	T44029	N/A	N/A
Power Amplifier	TESEQ	CBA 3G-100	T44030	N/A	N/A
Power Amplifier	TESEQ	CBA 6G-050	1041204	N/A	N/A
Dual Directional Coupler	TESEQ	C5982	95208	Nov. 08,17	Nov. 07,18
Dual Directional Coupler	TESEQ	C6187	95175	Nov. 08,17	Nov. 07,18
Dual Directional Coupler	TESEQ	CPH-274F	M251304-01	Nov. 08,17	Nov. 07,18
Test Software	Tonscend	TS+	2.5.0.0	N/A	N/A
Test Software	ADT	BVADT_RS_V 7.6.4-DG	N/A	N/A	N/A

- NOTE:** 1. The test was performed in RS chamber.  
2. The calibration interval of the above test instruments is 12 months and the calibrations are traceable to CEPREI/CHINA, GRGT/CHINA and NIM/CHINA.

### 4.3.3 TEST PROCEDURE

The test procedure was in accordance with IEC 61000-4-3

- a. The testing was performed in a fully-anechoic chamber.
- b. The frequency range is swept from 80 MHz to 1000 MHz, 1400MHz to 2000MHz, 2000MHz to 2700MHz with the signal 80% amplitude modulated with a 1kHz sine wave.
- c. The dwell time at each frequency shall not be less than the time necessary for the EUT to be exercised and to respond, but shall in no case be less than 0,5s.
- d. The field strength levels were 10V/m, 3V/m, 1V/m.
- e. The test was performed with the EUT exposed to both vertically and horizontally polarized fields on each of the four sides.

### 4.3.4 DEVIATION FROM TEST STANDARD

No Deviation

### 4.3.5 TEST SETUP

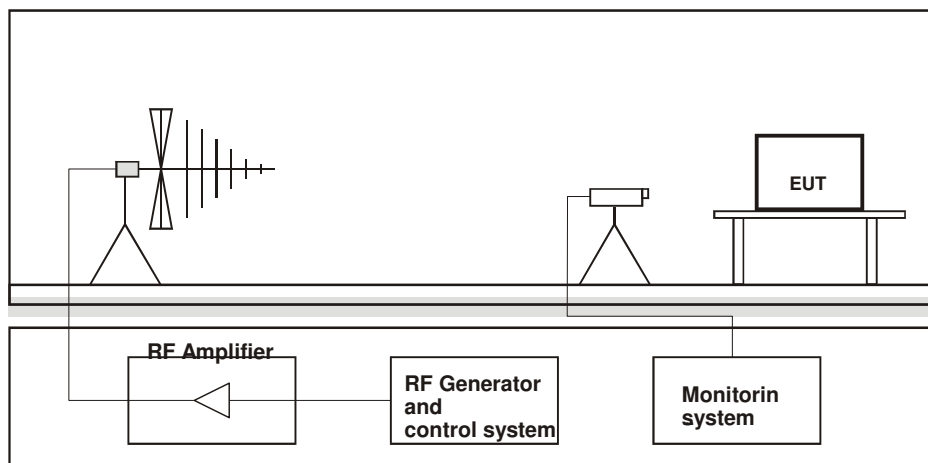

#### NOTE:

##### TABLETOP EQUIPMENT

The EUT installed in a representative system as described in section 7 of IEC 61000-4-3 was placed on a non-conductive table 0.8 meters in height. The system under test was connected to the power and signal wire according to relevant installation instructions.

##### FLOOR STANDING EQUIPMENT

The EUT installed in a representative system as described in section 7 of IEC 61000-4-3 was placed on a non-conductive wood support 0.1 meters in height. The system under test was connected to the power and signal wire according to relevant installation instructions.



### 4.3.6 TEST RESULTS

<b>TEST MODE</b>	See items 2.2	<b>TEST VOLTAGE</b>	See items 2.2
<b>ENVIRONMENTAL CONDITIONS</b>	26.7deg. C, 57.8% RH	<b>TESTED BY:</b> Andy	

Field Strength (V/m)	Test Frequency Note#1 (MHz)	Polarization of antenna (Horizontal / Vertical)	Test Distance (m)	Test Result	Remark
10	80 - 1000	H&V	3	A	N/A
3	1400 - 2000	H&V	3	A	N/A
1	2000 - 2700	H&V	3	A	N/A

Note#1:

Tested Israel SII Frequencies 89,100,107,144,163,196,244,315,434,460,600,825,845,880 MHz

**NOTE:** A: There was no change compared with initial operation during the test.



## 4.4 ELECTRICAL FAST TRANSIENT/BURST IMMUNITY TEST (EFT)

### 4.4.1 TEST SPECIFICATION

<b>Basic Standard:</b>	IEC 61000-4-4
<b>Test Voltage:</b>	Power Line/DC Line: 2kV
<b>Polarity:</b>	Positive & Negative
<b>Impulse Frequency:</b>	5 kHz
<b>Impulse Waveshape :</b>	5/50 ns
<b>Burst Duration:</b>	15 ms
<b>Burst Period:</b>	300 ms
<b>Test Duration:</b>	1 min.

### 4.4.2 TEST INSTRUMENTS

Equipment	Manufacturer	Model No.	Serial No.	Last Cal.	Next Cal.
Combination wave Module	TESEQ	CDN 3061	1361	May 02,18	May 01,19
Telecom Surge Module	TESEQ	NSG 3060 Mainframe	1404	May 02,18	May 01,19
Automated 3-Phase Coupling/ Decoupling Network	TESEQ	CDN 3063	2131	May 02,18	May 01,19
CDN	TESEQ	CDN HSS-2	34275	May 02,18	May 01,19
CDN	TESEQ	CDN 118	30741	May 02,18	May 01,19
Test Software	TESEQ	CDM 3061_0002.30	1361	N/A	N/A
Test Software	TESEQ	HVM 3060_0002.30	293	N/A	N/A
EFT Tester	HAEFELY	PEFT4010	150546	May 02,18	May 01,19
EFT Coupling Clamp	HAEFELY	IP4A	150407	May 02,18	May 01,19

- NOTE:** 1. The test was performed in EMS Room.  
 2. The calibration interval of the above test instruments is 12 months and the calibrations are traceable to CEPREI/CHINA, GRGT/CHINA and NIM/CHINA.

### 4.4.3 TEST PROCEDURE

- Both positive and negative polarity discharges were applied.
- The length of the “hot wire” from the coaxial output of the EFT generator to the terminals on the EUT should not exceed 0.5 meter ± 0.05 meter.
- The duration time of each test sequential was 1 minute.
- The transient/burst waveform was in accordance with IEC 61000-4-4, 5/50ns.

### 4.4.4 DEVIATION FROM TEST STANDARD

No deviation.



## 4.4.5 TEST SETUP

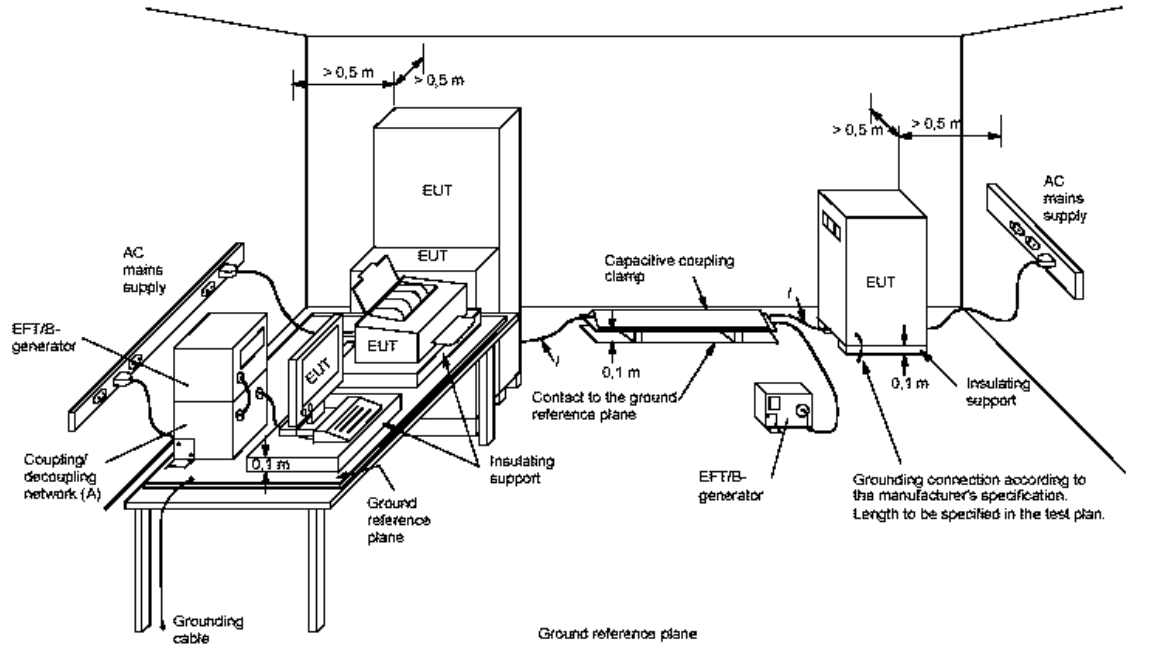

### **NOTE:** **TABLETOP EQUIPMENT**

The configuration consisted of a wooden table standing on the Ground Reference Plane and should be located 0.1m +/- 0.01m above the Ground Reference Plane.

The GRP consisted of a sheet of aluminum (at least 0.25mm thick and 2.5m square) connected to the protective grounding system. A minimum distance of 0.5m was provided between the EUT and the walls of the laboratory or any other metallic structure.

### **FLOOR STANDING EQUIPMENT**

The EUT installed in a representative system as described in section 7 of IEC 61000-4-4 and its cables, were isolated from the Ground Reference Plane by an insulating support that is 0.1-meter thick. The GRP consisted of a sheet of aluminum (at least 0.25mm thick and 2.5m square) connected to the protective grounding system.





### 4.4.6 TEST RESULTS

<b>TEST MODE</b>	See items 2.2	<b>TEST VOLTAGE</b>	See items 2.2
<b>ENVIRONMENTAL CONDITIONS</b>	25.6 deg. C, 58.4% RH	<b>TESTED BY:</b> Jack	

Pulse Voltage	2.0 kV		kV		kV		kV	
	+	-	+	-	+	-	+	-
L	A	A	/	/	/	/	/	/
N	A	A	/	/	/	/	/	/
PE	A	A	/	/	/	/	/	/
L+N	A	A	/	/	/	/	/	/
L+PE	A	A	/	/	/	/	/	/
N+PE	A	A	/	/	/	/	/	/
L+N+PE	A	A	/	/	/	/	/	/
DC Line	A	A	/	/	/	/	/	/

**NOTE:** A: There was no change compared with initial operation during the test.



## 4.5 SURGE IMMUNITY TEST

### 4.5.1 TEST SPECIFICATION

<b>Basic Standard:</b>	IEC 61000-4-5
<b>Wave-Shape:</b>	Combination Wave 1.2/50 us Open Circuit Voltage 8 /20 us Short Circuit Current
<b>Test Voltage:</b>	AC Power Line :Line to Line: 1kV Line to PE: 2kV
<b>Surge Input/Output:</b>	L-N, L-PE, N-PE
<b>Generator Source</b>	2 ohm between networks
<b>Impedance:</b>	12 ohm between network and ground
<b>Polarity:</b>	Positive/Negative
<b>Phase Angle:</b>	0° /90°/180°/270°
<b>Pulse Repetition Rate:</b>	1 time / 60 sec.
<b>Number of Tests:</b>	5 positive and 5 negative at selected points

### 4.5.2 TEST INSTRUMENTS

Equipment	Manufacturer	Model No.	Serial No.	Last Cal.	Next Cal.
Combination wave Module	TESEQ	CDN 3061	1361	May 02,18	May 01,19
Telecom Surge Module	TESEQ	NSG 3060 Mainframe	1404	May 02,18	May 01,19
Automated 3- Phase Coupling/ Decoupling Network	TESEQ	CDN 3063	2131	May 02,18	May 01,19
CDN	TESEQ	CDN HSS-2	34275	May 02,18	May 01,19
CDN	TESEQ	CDN 118	30741	May 02,18	May 01,19
Test Software	TESEQ	CDM 3061_0002.30	1361	N/A	N/A
Test Software	TESEQ	HVM 3060_0002.30	293	N/A	N/A

- NOTE:** 1. The test was performed in EMS Room.  
2. The calibration interval of the above test instruments is 12 months and the calibrations are traceable to CEPREI/CHINA, GRGT/CHINA and NIM/CHINA.

### 4.5.3 TEST PROCEDURE

- a. For EUT power supply:

The surge is to be applied to the EUT power supply terminals via the capacitive coupling network. Decoupling networks are required in order to avoid possible adverse effects on equipment not under test that may be powered by the same lines, and to provide sufficient decoupling impedance to the surge wave. The power cord between the EUT and the coupling/decoupling networks shall be 2 meters in length (or shorter).

- b. For test applied to unshielded unsymmetrically operated interconnection lines of EUT:

The surge is applied to the lines via the capacitive coupling. The coupling / decoupling networks shall not influence the specified functional conditions of the EUT. The interconnection line between the EUT and the coupling/decoupling networks shall be 2 meters in length (or shorter).

- c. For test applied to unshielded symmetrically operated interconnection / telecommunication lines of EUT:

The surge is applied to the lines via gas arrestors coupling. Test levels below the ignition point of the coupling arrestor cannot be specified. The interconnection line between the EUT and the coupling/decoupling networks shall be 2 meters in length (or shorter).

### 4.5.4 DEVIATION FROM TEST STANDARD

No deviation.

### 4.5.5 TEST SETUP

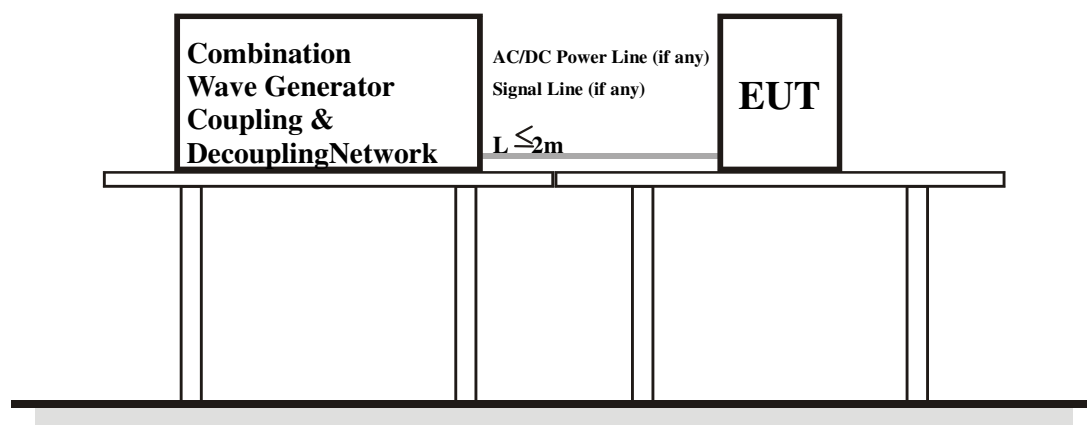



### 4.5.6 TEST RESULTS

<b>TEST MODE</b>	See items 2.2	<b>TEST VOLTAGE</b>	See items 2.2
<b>ENVIRONMENTAL CONDITIONS</b>	24.8deg. C, 56.7% RH	<b>TESTED BY:</b> Jack	

**AC/DC Power port:**

\Phase angle \ Test result \Voltage (kV) \ Test point\ Polarity			0°	90°	180°	270°	DC Power Port
1.0	L-N	+	B	B	B	B	N/A
		-	B	B	B	B	N/A
2.0	L-PE	+	B	B	B	B	N/A
		-	B	B	B	B	N/A
2.0	N-PE	+	B	B	B	B	N/A
		-	B	B	B	B	N/A
0.5	DC Line	+	N/A	N/A	N/A	N/A	A
		-	N/A	N/A	N/A	N/A	A

**NOTE:** A: There was no change compared with initial operation during the test.  
 B: The EUT would reduce power and restart during the test, and it could recover automatically.



## 4.6 IMMUNITY TO CONDUCTED DISTURBANCES INDUCED BY RF FIELDS (CS)

### 4.6.1 TEST SPECIFICATION

<b>Basic Standard:</b>	IEC 61000-4-6
<b>Frequency Range:</b>	0.15 MHz - 80 MHz
<b>Field Strength:</b>	10V <sub>r.m.s</sub>
<b>Modulation:</b>	1kHz Sine Wave, 80%, AM Modulation
<b>Frequency Step:</b>	1 % of fundamental
<b>Coupled Cable:</b>	Power Mains & DC Power Line
<b>Coupling Device:</b>	CDN-M3 (3 wires) & Clamp

### 4.6.2 TEST INSTRUMENTS

Equipment	Manufacturer	Model No.	Serial No.	Last Cal.	Next Cal.
Signal Generator	Rohde&Schwarz	SME06	829498/006	Oct. 20,17	Oct. 19,18
CDN	Luthi	L-801M2/M3	2015	Sep.27,18	Sep. 26,19
CDN(AUX)	TESEQ	CDN M016	27452	Nov. 15,17	Nov. 14,18
CDN	TESEQ	T200A	26944	Apr. 11,18	Apr. 10,19
CDN	TESEQ	T400A	26536	Apr. 11,18	Apr. 10,19
CDN	TESEQ	ST08A	32256	Apr. 11,18	Apr. 10,19
6dB 50Watt Attenuator	HUBER+SUHNER	5906.17.0005	303688	Oct. 20,17	Oct. 19,18
Power Amplifier	PRANA	DR 220	1512-1788	NA	NA
Electromagnetic Injection Clamp	Luthi	EM101	35640	Sep.14,18	Sep. 13,19
Test Software	Tonscend	TS+	2.5.0.0	N/A	N/A
Test Software	ADT	BVADT_CS_V 7.6.2	N/A	N/A	N/A

- NOTE:** 1. The test was performed in CS test room.  
 2. The calibration interval of the above test instruments is 12 months and the calibrations are traceable to CEPREI/CHINA, GRGT/CHINA and NIM/CHINA.



### 4.6.3 TEST PROCEDURE

- a. The EUT shall be tested within its intended operating and climatic conditions.
- b. An artificial hand was placed on the hand-held accessory and connected to the ground reference plane.
- c. The test shall be performed with the test generator connected to each of the coupling and decoupling devices in turn, while the other non-excited RF input ports of the coupling devices are terminated by a 50-ohm load resistor.
- d. The frequency range is swept from 150 kHz to 80 MHz, using the signal level established during the setting process and with a disturbance signal of 80 % amplitude. The signal is modulated with a 1 kHz sine wave, pausing to adjust the RF signal level or the switch coupling devices as necessary. Where the frequency is swept incrementally, the step size shall not exceed 1 % of the preceding frequency value.
- e. The dwell time of the amplitude modulated carrier at each frequency shall not be less than the time necessary for the EUT to be exercised and to respond, but shall in no case be less than 0,5 s. The sensitive frequencies (e.g. clock frequencies) shall be analyzed separately.
- f. Attempts should be made to fully exercise the EUT during testing, and to fully interrogate all exercise modes selected for susceptibility.

### 4.6.4 DEVIATION FROM TEST STANDARD

No deviation.

## 4.6.5 TEST SETUP

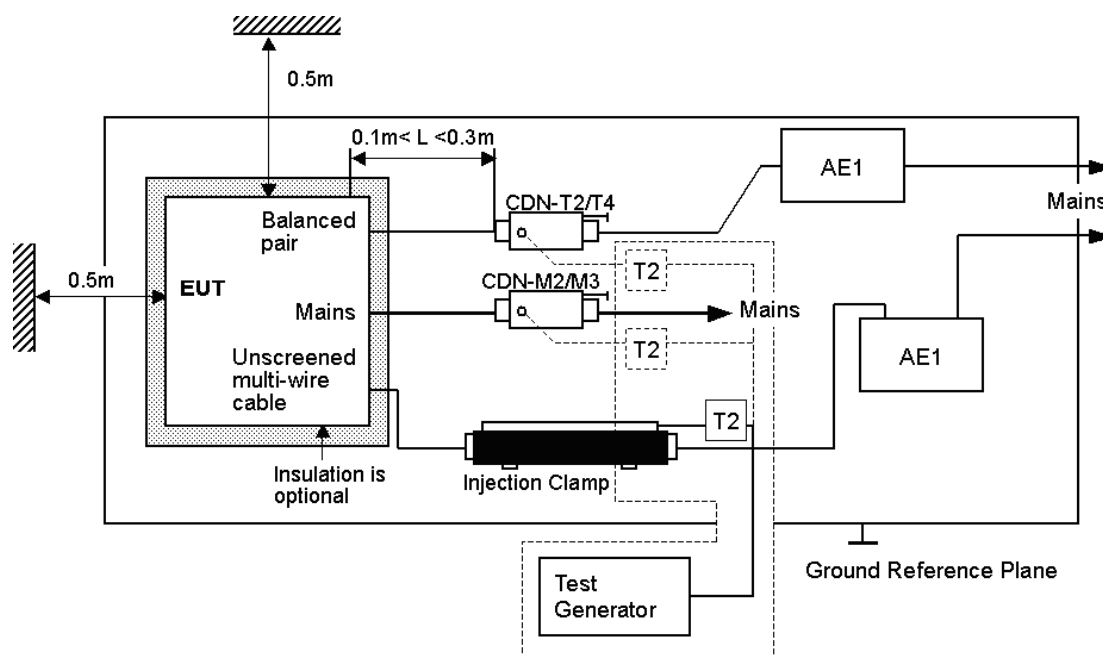

NOTE: The EUT clearance from any metallic obstacles shall be at least 0.5m.  
All non-excited input ports of the CDNs shall be terminated by  $50\Omega$  loads.

### NOTE:

#### FLOOR-STANDING EQUIPMENT

The equipment to be tested is placed on an insulating support of 0.1 meters height above a ground reference plane. All relevant cables shall be provided with the appropriate coupling and decoupling devices at a distance between 0.1 meters and 0.3 meters from the projected geometry of the EUT on the ground reference plane.



### 4.6.6 TEST RESULTS

<b>TEST MODE</b>	See items 2.2	<b>TEST VOLTAGE</b>	See items 2.2
<b>ENVIRONMENTAL CONDITIONS</b>	26.8deg. C, 57.6% RH	<b>TESTED BY:</b> Andy	

Voltage (V)	Test Frequency Note#1 (MHz)	Tested Line	Injection Method.	Test Result	Remark
10	0.15 – 80	AC Line	CDN-M3	A	N/A
10	0.15 – 80	DC Line	Clamp	A	N/A

Note#1: Tested Israel SII Frequencies 0.2,0.53,1,1.5,7.1,13.56,21,27.12,40.68,65,68 MHz

**NOTE:** A: There was no change compared with initial operation during the test.





## 4.7 POWER FREQUENCY MAGNETIC FIELD IMMUNITY TEST

### 4.7.1 TEST SPECIFICATION

<b>Basic Standard:</b>	IEC 61000-4-8
<b>Frequency Range:</b>	50Hz
<b>Field Strength:</b>	30A/m
<b>Observation Time:</b>	5 minute
<b>Inductance Coil:</b>	Rectangular type, 1mx1m

### 4.7.2 TEST INSTRUMENTS

Equipment	Manufacturer	Model No.	Serial No.	Last Cal.	Next Cal.
Magnetic Field Tester	HAEFELY	MAG100.1	150579	Oct. 20,17	Oct. 19,18
Test Software	N/A	N/A	N/A	N/A	N/A

- NOTE:** 1. The test was performed in Shielding Room 843.  
2. The calibration interval of the above test instruments is 12 months and the calibrations are traceable to CEPREI/CHINA, GRGT/CHINA and NIM/CHINA.

### 4.7.3 TEST PROCEDURE

- The equipment is configured and connected to satisfy its functional requirements.
- The power supply, input and output circuits shall be connected to the sources of power supply, control and signal.
- The cables supplied or recommended by the equipment manufacturer shall be used. 1 meter of all cables used shall be exposed to the magnetic field.

### 4.7.4 DEVIATION FROM TEST STANDARD

No deviation.



## 4.7.5 TEST SETUP

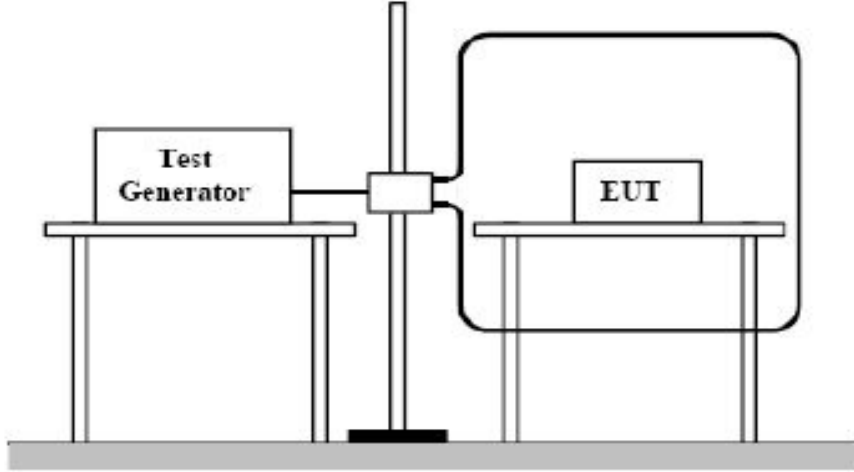

### NOTE:

#### TABLETOP EQUIPMENT

The equipment shall be subjected to the test magnetic field by using the induction coil of standard dimension (1 m x 1 m). The induction coil shall then be rotated by 90 degrees in order to expose the EUT to the test field with different orientations.

#### FLOOR-STANDING EQUIPMENT

The equipment shall be subjected to the test magnetic field by using induction coils of suitable dimensions. The test shall be repeated by moving and shifting the induction coils, in order to test the whole volume of the EUT for each orthogonal direction. The test shall be repeated with the coil shifted to different positions along the side of the EUT, in steps corresponding to 50 % of the shortest side of the coil. The induction coil shall then be rotated by 90 degrees in order to expose the EUT to the test field with different orientations.



### 4.7.6 TEST RESULTS

<b>TEST MODE</b>	See items 2.2	<b>TEST VOLTAGE</b>	See items 2.2
<b>ENVIRONMENTAL CONDITIONS</b>	24.8 deg. C, 56.7% RH	<b>TESTED BY:</b> Jack	

Magnetic field direction	Testing result	Remark
X - Axis	A	30A/m
Y - Axis	A	30A/m
Z - Axis	A	30A/m

**NOTE:** A: There was no change compared with initial operation during the test.



## 5 PHOTOGRAPHS OF THE TEST CONFIGURATION

CONDUCTED EMISSION TEST



RADIATED EMISSION TEST (30MHz~1GHz)

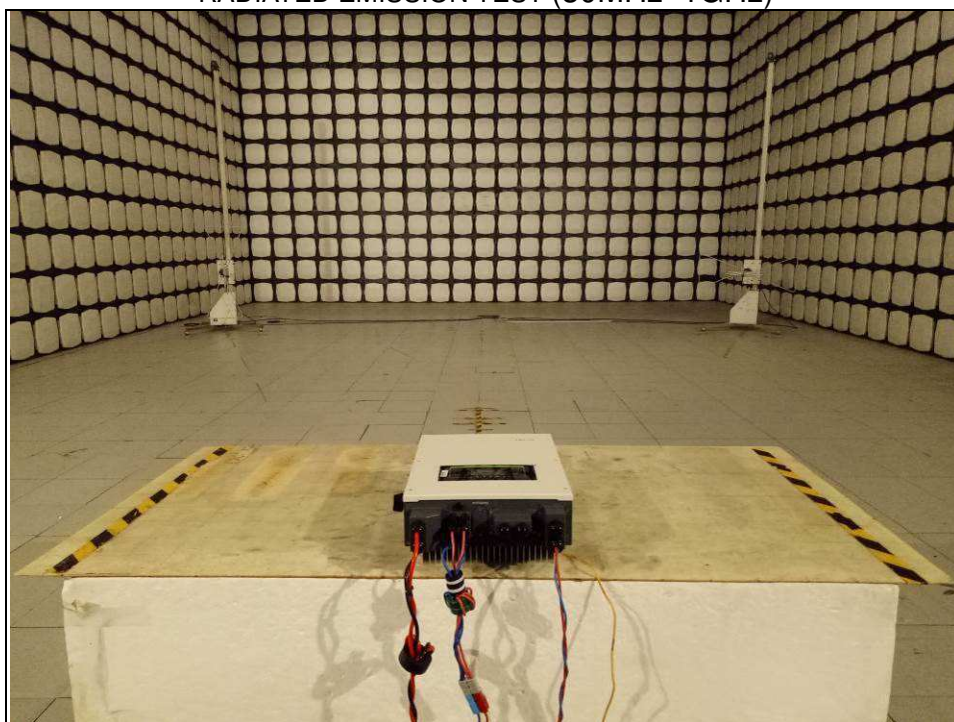

ESD TEST



RS TEST





EFT TEST

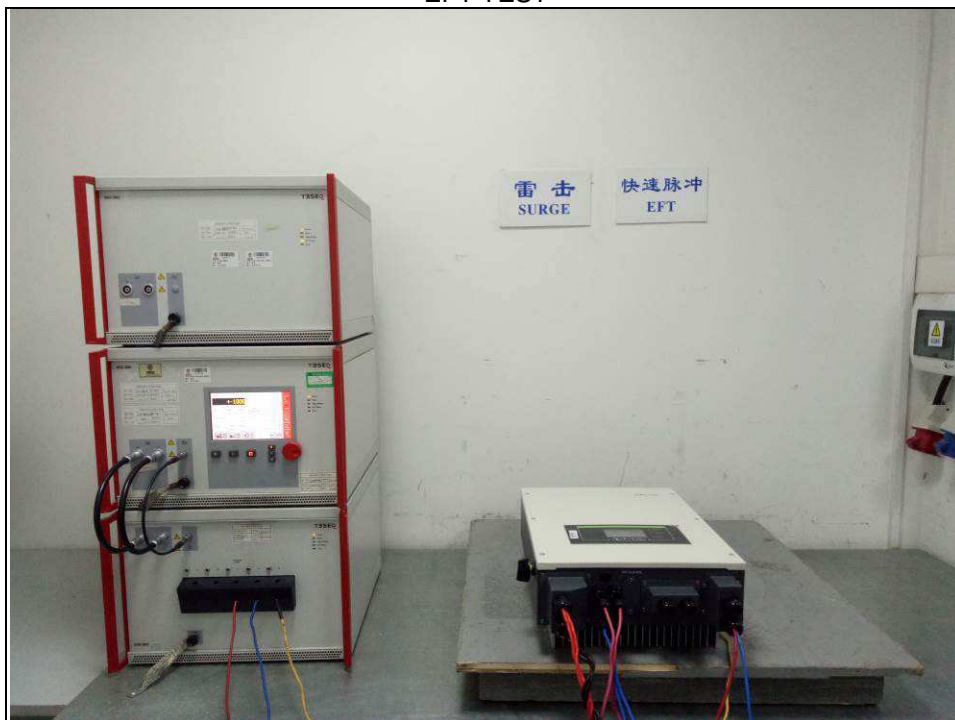

EFT AT DC LINE TEST



### SURGE TEST



### CONDUCTED SUSCEPTIBILITY TEST

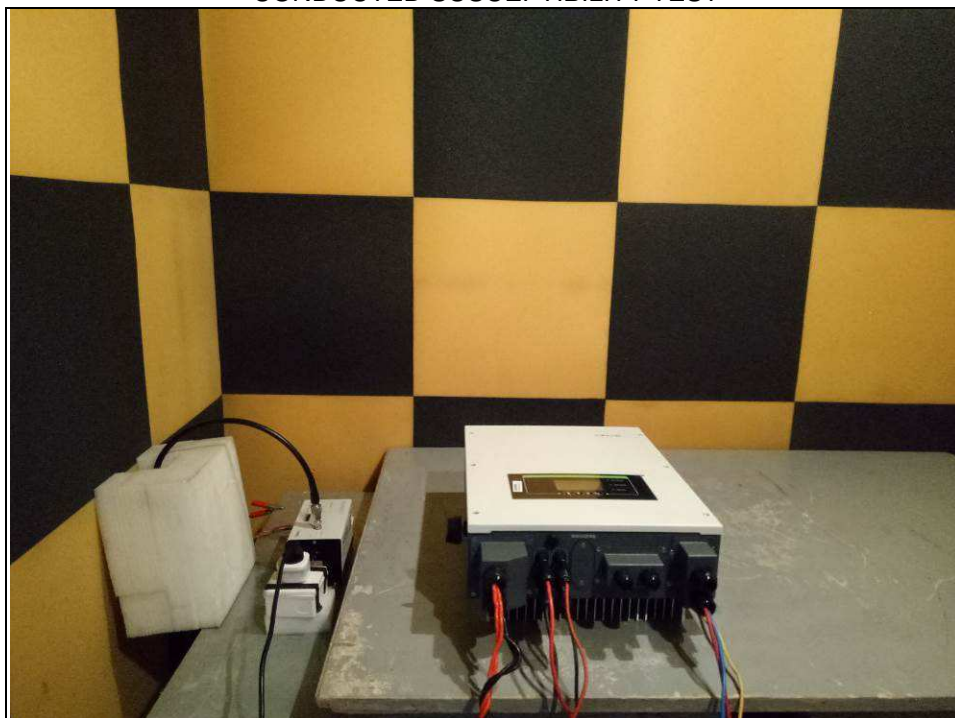

CONDUCTED SUSCEPTIBILITY AT DC LINE TEST

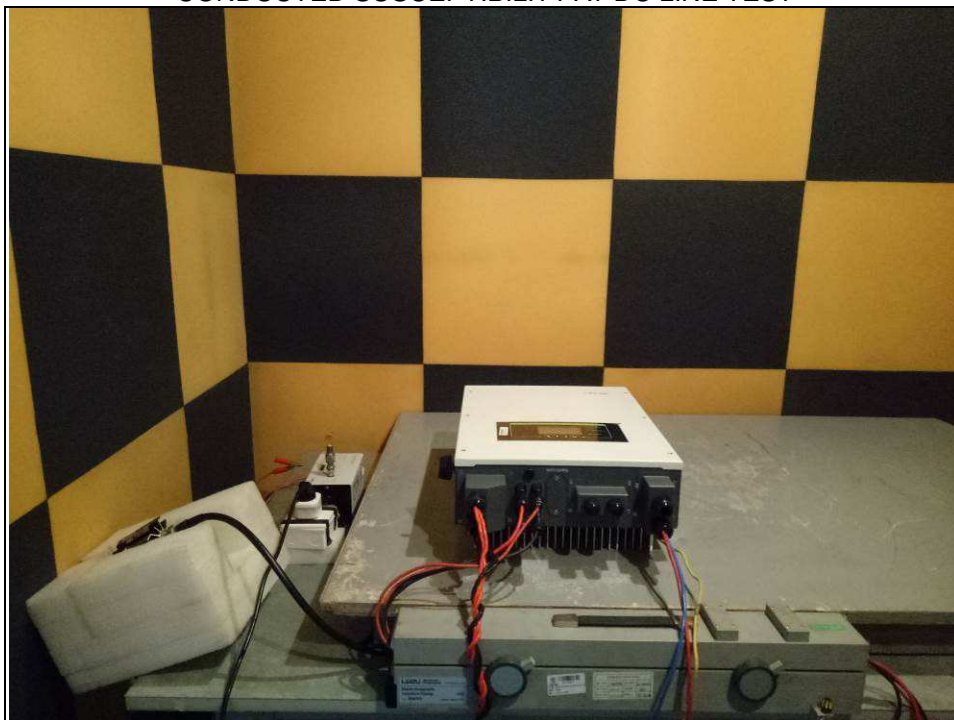

POWER-FREQUENCY MAGNETIC FIELDS TEST

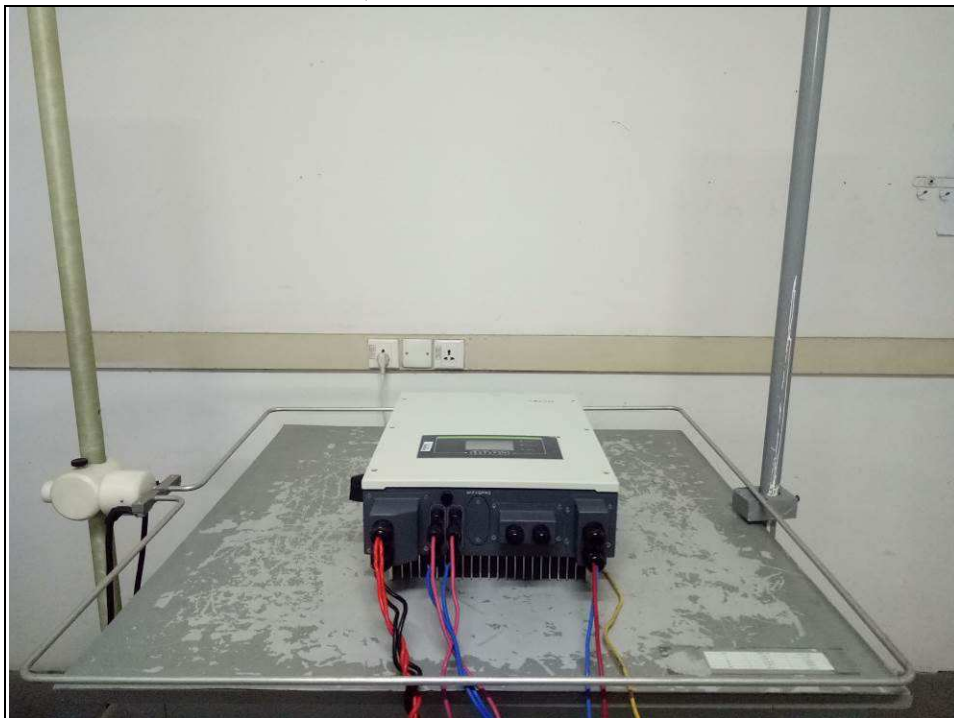





**BUREAU  
VERITAS**

Test Report No.: C200320N024-3

## **6 APPENDIX A – MODIFICATIONS RECORDERS FOR ENGINEERING CHANGES TO THE EUT BY THE LAB**

No any modifications were made to the EUT by the lab during the test.

**---END---**